



PREMIUM STANDS  
**CATALOG**



DESIGNED & ENGINEERED  
IN GERMANY.



Gravity® is a brand of the Adam Hall Group.



**SOUND** TECHNOLOGY   **LIGHT** TECHNOLOGY   **STAGE** EQUIPMENT   **HARDWARE** FOR FLIGHTCASES

ADAM HALL GROUP BRANDS



DISTRIBUTION BRANDS







reddot winner 2016



german  
brand  
award  
17  
nominee



GERMAN  
DESIGN  
AWARD  
WINNER  
2017



reddot winner 2021

## DESIGN MEETS QUALITY

### PREMIUM STANDS BY GRAVITY®

Whether you're a stage-man or a studio-hound, you know exactly what matters in a microphone-, speaker-, lighting- or instrument- stand: Stability, strength, durability, reliability and easy handling. In short: Quality. To this end, our Gravity® products are manufactured from the highest quality materials: super sturdy precision tubes, die-cast zinc and dual injection-moulded thermoplastic.

But the stands also need to look good. And this is where the perfect combination of simple functionality and good looks makes Gravity® stand out from the crowd. See for yourself: Check out the contemporary G-rings for colour-coding and identification, or the new super-rugged Gravity® Touring Series, specially developed for the rental sector.

Because we both recognise and meet your requirements for stands and accessories, we are able to offer a 5-year warranty on all Gravity® products.

#### Gravity® - Take The Stage

- ✓ Stands and accessories for stage, studio and home use.
- ✓ 5-year warranty on all Gravity® products.
- ✓ Professional functionality with innovative details.
- ✓ Designed and engineered in Germany.
- ✓ Ultra-durable construction, built to last.
- ✓ High strength precision tubing and die-cast zinc components.
- ✓ Soft touch rubber-coated clamps and knobs.
- ✓ Double injection molded adjustment knobs.
- ✓ Replaceable rubber marker rings for color coding and personalizing your stand.

[gravitystands.com](http://gravitystands.com)

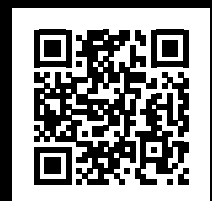



## G-RINGS THE STYLE FACTOR

At Gravity®, we believe that stands are more than just accessories. Ultimately, they are part of the show. That's why we build them for heavy duty use and easy, ergonomic handling. But we also opted for a stylish look that sets them apart from dime-a-dozen stands and makes a strong visual statement.

Gravity® products feature our unique sheen green "G" rings that are replaceable in seconds. Available in a variety of attractive colors, you can now customize your stands with additional ring packs and match them to your show's visuals, music genre or personal preference.

What's more, the smart "G" ring concept provides convenient color coding to indicate a stand's intended purpose, placement on stage or the performer to use it. Just pick your colors to add style and distinction to your stands, or choose vanta black "G" rings for a classic, discreet look. Black rings are included with all Gravity® products.

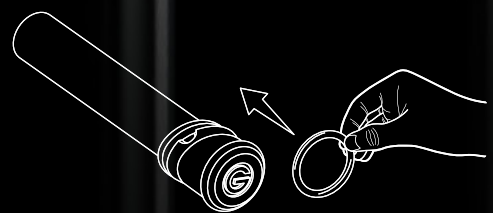

### AVAILABLE COLORS:

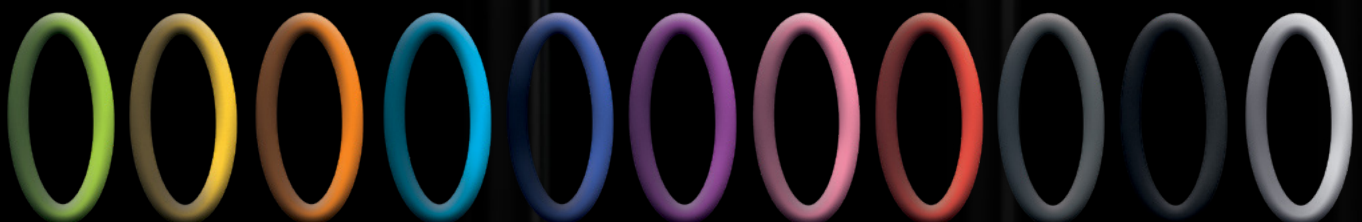

Sheen  
Green

Sunshine  
Yellow

Electric  
Orange

Deep Sky  
Blue

Deep Sea  
blue

Power  
purple

Misty Rose  
Pink

Lust  
Red

Concrete  
Grey

Vanta  
Black

Ghost  
White

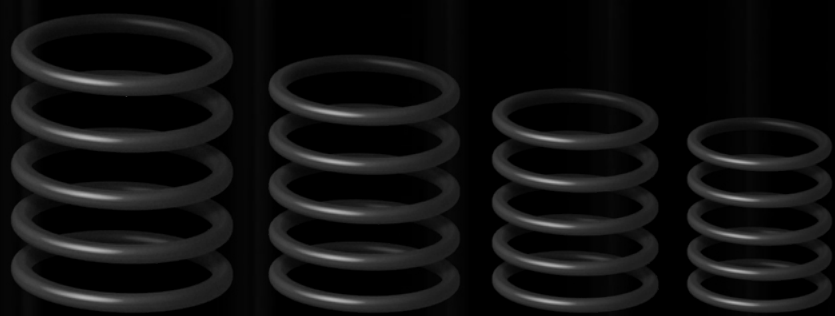

## Universal Ring Pack

suitable for all Gravity® products.

Contents: 5 x 15 mm, 5 x 20 mm,  
5 x 25 mm, 5 x 30 mm

Vanta Black:	GRP5555BLK1
Ghost White:	GRP5555WHT1
Concrete Grey:	GRP5555GRY1
Lust Red:	GRP5555RED1
Sunshine Yellow:	GRP5555YEL1
Sheen Green:	GRP5555GRN1
Deep Sky Blue:	GRP5555BLU1
Deep Sea Blue:	GRP5555BLU2
Electric Orange:	GRP5555ORG1
Misty Rose Pink:	GRP5555PNK1
Power Purple:	GRP5555PPL1





## **GRAVITY®** ORIGINAL REPLACEMENT PARTS

Built for durability and longevity, Gravity® products are constructed from premium quality materials, such as heavy duty aluminum and steel, tough die-cast zinc and hardwearing thermoplastics.

In the unlikely event that the strains of stage and studio use take their toll, we offer a comprehensive selection of original replacement parts.

Gravity® replacement parts are field serviceable enabling easy repair to extend the life of your Gravity® product and provide an eco-friendly alternative to the planned obsolescence of throwaway designs.





## CONTENTS

Microphone Stands.....	P. 16
Speaker Stands.....	P. 56
Lighting Stands.....	P. 90
Keyboard Stands.....	P. 104
Music Stands.....	P. 114
Guitar Stands.....	P. 122
Multimedia Equipment.....	P. 136
Seats & Benches.....	P. 164
Bags & Transport Systems.....	P. 172







# TOURING FOR **ETERNAL GLORY**



## TOURS ARE YOURS

On tour you have to work hard every day and you need to be as fast as possible. Designed especially for touring heroes like you: The super solid Gravity® Touring Series. Rugged stands with unlosable metal knobs, firm grip and quick boom adjustments. Save time and earn glory. Day after day. Job after job.

**TOURING** SERIES

**Gravity**®   
take the stage



# TOURING SERIES TOURS ARE YOURS

## TMS 4322 B

TOURING SERIES TRIPOD MIC  
STAND WITH 2-POINT ADJUSTMENT  
TELESCOPING BOOM

Details on PAGE 25

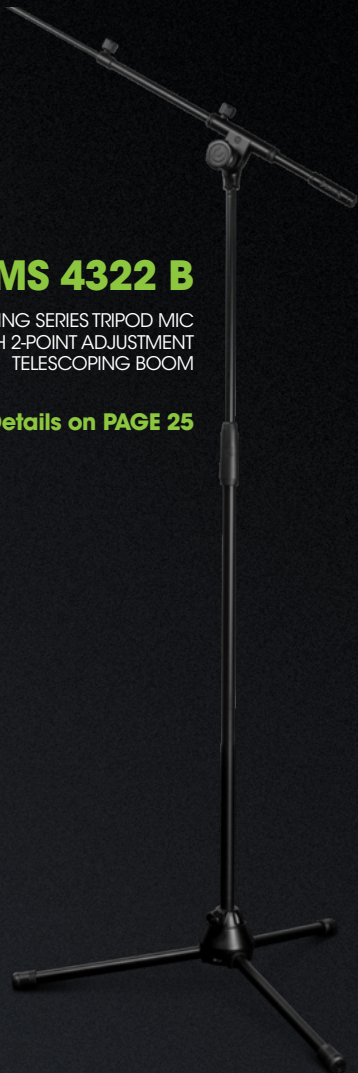

## TLS 431 B

TOURING-LIGHTING STAND  
WITH SQUARE STEEL BASE

Details on PAGE 92



## TSP 5212 LB

TOURING SERIES STEEL SPEAKER  
STAND WITH AUTO LOCKPIN®

Details on PAGE 59



## TSP 2332 B

ADJUSTABLE TOURING SPEAKER  
POLE 35 MM TO M20 1400 MM

Details on PAGE 72



## TLS P 431

TOURING SERIES DISTANCE POLE  
FOR GTLS431B / GLS431B / GLS331B

Details on PAGE 93



Get your tough stuff at  
[gravitystands.com/TOURINGSERIES](http://gravitystands.com/TOURINGSERIES)





**TMS 4332 B**

TOURING SERIES MIC STAND WITH  
TRIPOD FOLDING BASE AND 2-POINT  
ADJUSTMENT TELESCOPING BOOM

**Details on PAGE 23**

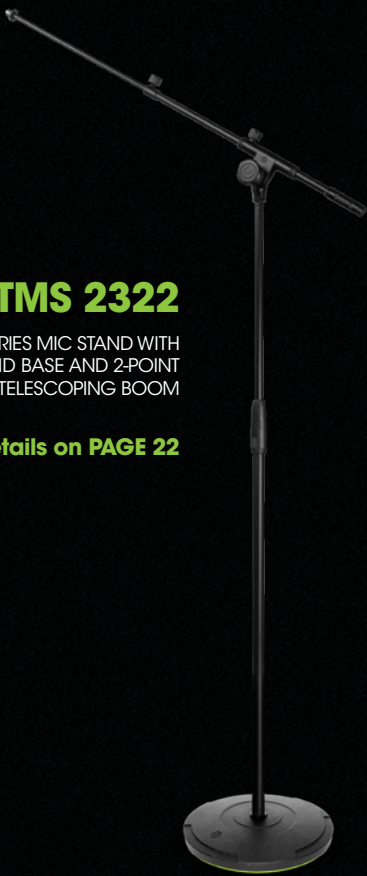

**TMS 2322**

TOURING SERIES MIC STAND WITH  
ROUND BASE AND 2-POINT  
ADJUSTMENT TELESCOPING BOOM

**Details on PAGE 22**



**TMS 4232 B**

TOURING SERIES MIC STAND SHORT  
WITH TRIPOD FOLDING BASE AND  
2-POINT ADJUSTMENT  
TELESCOPING BOOM

**Details on PAGE 23**



**TMS 2222**

TOURING SERIES SHORT MIC STAND  
WITH ROUND BASE AND 2-POINT  
ADJUSTMENT TELESCOPING BOOM

**Details on PAGE 20**



**TMS 23**

TOURING SERIES MIC STAND  
WITH ROUND BASE

**Details on PAGE 21**

# BON VOYAGE

Every bit of weight counts when you're travelling by plane or truck from one gig to the next. After all, you can't always rely on finding the right tool available at the concert venue. In order for you to always be flexible, Gravity® has developed the Traveler series with lightweight, practical stands and accessories.

**TRAVELER** SERIES







EUROPAISCHE UNION  
BUNDESREPUBLIK  
DEUTSCHLAND



PASSPORT

Gravity



## MA DSB 01

TRAVELER DRUMSTICK HOLDER

Details on PAGE 38

## MA 3D A POP 1

TRAVELER 3D ARM WITH POP FILTER

Details on PAGE 38

## MA 3D A

TRAVELER 3D ARM

Details on PAGE 38



## NS MS 03

FOLDABLE TRAVELER SHEET  
MUSIC HOLDER

Details on PAGE 39

## MA T TH 01

TRAVELER UNIVERSAL  
TABLET HOLDER

Details on PAGE 150

## MA TE 01

TRAVELER EXTENSION

Details on PAGE 39





# TRAVELER SERIES BON VOYAGE

## NS MS 02

TRAVELER SHEET MUSIC HOLDER

Details on PAGE 39

## MS 5311 B

TRAVELER MICROPHONE STAND

Details on PAGE 26

## SP 5112 B

TRAVELER SPEAKER STAND

Details on PAGE 62

## MA TRAY 3

TILTABLE TRAVELER TRAY

Details on PAGE 39





# MICROPHONE STANDS

Gravity® microphone stands are easy to handle and built to last. Featuring strong, thick-walled tubing with a tough powder coating finish, they are available in folding tripod and round cast iron base versions with ergonomic clutch handles and set screw knobs for quick, convenient setup. Gravity® microphone stands include straight 2-point boom adjustment models providing maximum user comfort.



# MICROPHONE STANDS

## FEATURES



Telescopic boom with quick release clamp for easy adjustment



Comfortable ergonomic knobs with thermoplastic rubber coating



Super accurate and stable 2-point boom joint



Soft touch rubber clutch handle for nonslip height adjustment



Specially tooled ergonomic retainer nut



High quality rubber feet



Ultra-sturdy tripod leg collar











Circular base plate with rubber bottom for acoustic isolation and surface protection



Heavy-duty tubing

## MICROPHONE STAND ORDER GUIDE

Gravity® Microphone Stand product numbers use a simple code.  
Please, use the guide below for correct model identification.

	BASE TYPE	HEIGHT	BOOM ADJUSTMENT	BOOM TYPE	EXAMPLE
					
					
<b>GMS</b>	<b>4</b>	<b>3</b>	<b>2</b>	<b>2</b>	<b>GMS4322</b>
Gravity Microphone Stand					RESULTING ARTICLE NUMBER

# MICROPHONE STANDS

## TOURING SERIES

### TMS 2222

SHORT TOURING SERIES MICROPHONE STAND  
WITH ROUND BASE AND 2-POINT ADJUSTMENT  
TELESCOPING BOOM

The Gravity® Touring series microphone stands are built to be extremely sturdy with especially strong steel tubing. The boom mount of the Gravity® TMS 2222 short microphone stand is crafted from indestructible die-cast zinc and has an adjustment range of 51 to 88 cm. The locking screw - which is unloosable - can be quickly and easily engaged with just a  $\frac{3}{4}$  turn, ensuring the boom stays securely in place. Height adjustment is just as easy and extremely quick via the easy-grip, triangular tightening sleeve.

Another standout feature of this Microphone stand is its improved round base which provides a stable and secure footing thanks to its weight and flat rubber feet. Made for touring, the Gravity® TMS 2222 round base mic stand will stand with you on your gigs with its sturdy and long-lasting construction.



Product number	GTMS2222
Product type	Stands and tripods
Type	Microphone stands
Tubing material	Steel
Colour	Black
Surface	Powder coated
Min. height	480 mm
Max. height	730 mm
Transport length	550 mm
Height adjustment	Yes
Base type	Round base
Base material	Cast iron
Base diameter	270 mm
Base weight	3.6 kg
Boom model	2-point adjustment
Boom length	510 - 880 mm
Weight	5.9 kg



## TMS 23

### TOURING SERIES MICROPHONE STAND WITH ROUND BASE

Height adjustment is easy and extremely quick via the easy-grip, triangular tightening sleeve. Another standout feature of this Microphone stand is its improved round base which provides a stable and secure footing thanks to its weight and flat rubber feet.

Thanks to VARI®-WEIGHT compatibility, the base plate can be made heavier with additional weight plates.

Made for touring, the Gravity® TMS 23 round base mic stand will stand with you on your gigs with its sturdy and long-lasting construction.

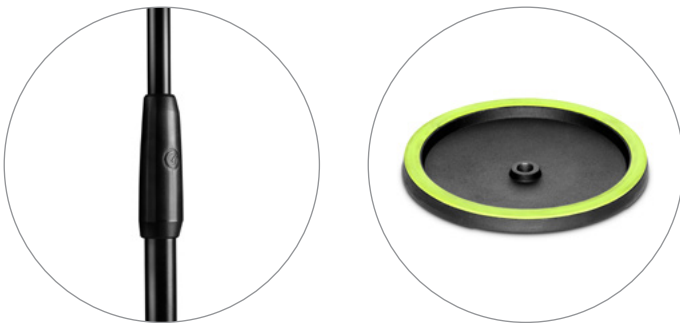

Product number	GTMS23
Product type	Stands and tripods
Type	Microphone stands
Tubing material	Steel
Colour	Black
Surface	Powder coated
Min. height	1000 mm
Max. height	1600 mm
Transport length	1000 mm
Height adjustment	Yes
Base type	Round base
Base material	Cast iron
Base diameter	270 mm
Base weight	3.6 kg
Weight	5.66 kg



Get your tough stuff at [gravitystands.com/TOURINGSERIES](https://gravitystands.com/TOURINGSERIES)

# MICROPHONE STANDS

## TOURING SERIES

### TMS 2322

TOURING SERIES MICROPHONE STAND WITH  
ROUND BASE AND 2-POINT ADJUSTMENT  
TELESCOPING BOOM

The Gravity® Touring series microphone stands are built to be extremely sturdy with especially strong steel tubing. The boom mount of the Gravity® TMS 2322 is crafted from indestructible die-cast zinc and has an adjustment range of 51 to 88 cm.

The locking screw - which is unloosable - can be quickly and easily engaged with just a  $\frac{3}{4}$  turn, ensuring the boom stays securely in place.

Height adjustment is just as easy and extremely quick via the easy-grip, triangular tightening sleeve.

Another standout feature of this Microphone stand is its improved round base which provides a stable and secure footing thanks to its weight and flat rubber feet.

Made for touring, the Gravity® TMS 2322 round base mic stand will stand with you on your gigs with its sturdy and long-lasting construction.

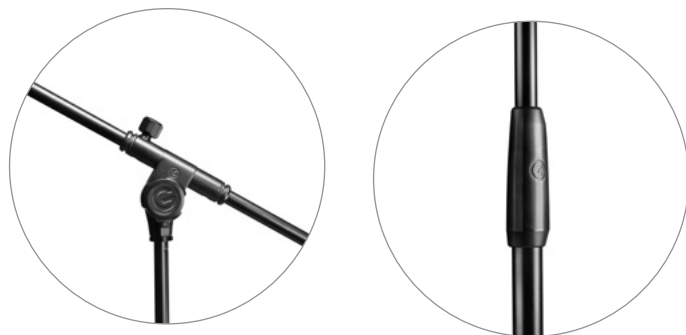

Product number	GTMS2322
Product type	Stands and tripods
Type	Microphone stands
Tubing material	Steel
Colour	Black
Surface	Powder coated
Min. height	1000 mm
Max. height	1680 mm
Transport length	1000 mm
Height adjustment	Yes
Base type	Round base
Base material	Cast iron
Base diameter	270 mm
Base weight	3.6 kg
Boom model	2-point adjustment
Telescoping	Yes
Boom length	510 - 880 mm
Weight	6.67 kg



Crafted from robust tubular steel, the TMS 4232 B / TMS 4332 B features three folding feet, ensuring a secure stance even in demanding environments. The bell-and-boom holder constructed from indestructible die-cast zinc guarantees longevity under constant handling.

Effortless adjustment is key during hectic set-ups, which is why the boom is equipped with a T-bar locking screw for quick and secure positioning. Transporting the stand is made easy thanks to its compatibility with standard microphone stand tube cases.

To prevent the loss of vital components during the hustle of touring, solid metal knobs are securely affixed to the stand. Setting up and dismantling the TMS 4232 B / TMS 4332 B is a breeze: a mere 3/4 turn of the adjusting screw locks the boom securely in place, while height adjustments are easily achieved with the ergonomic triangular clamping sleeve.



## TMS 4232 B

TOURING SERIES MICROPHONE STAND SHORT WITH TRIPOD FOLDING BASE AND 2-POINT ADJUSTMENT TELESCOPING BOOM

Product number	GTMS4232B
Product type	Stands and tripods
Type	Microphone stands
Tubing material	Steel
Colour	Black
Surface	Powder coated
Min. height	520 mm
Max. height	760 mm
Transport length	600 mm
Height adjustment	Yes
Base type	Tripod
Base material	Zinc die-cast
Boom model	2-point adjustment
Telescoping	Yes
Boom length	510 - 880 mm
Weight	2.7 kg



## TMS 4332 B

TOURING SERIES MICROPHONE STAND WITH TRIPOD FOLDING BASE AND 2-POINT ADJUSTMENT TELESCOPING BOOM

Product number	GTMS4332B
Product type	Stands and tripods
Type	Microphone stands
Tubing material	Steel
Colour	Black
Surface	Powder coated
Min. height	1000 mm
Max. height	1700 mm
Transport length	1000 mm
Height adjustment	Yes
Base type	Tripod
Base material	Zinc die-cast
Boom model	2-point adjustment
Telescoping	Yes
Boom length	510 - 880 mm
Weight	3.5 kg

# MICROPHONE STANDS

## TOURING SERIES

### TMS 4321 B

#### TOURING SERIES TRIPOD MIC STAND WITH 2-POINT ADJUSTMENT STANDARD BOOM

Tours and events often operate under hard conditions and time pressures. Microphone stands are thrown around and not generally treated gently. That's why Gravity® Touring series microphone stands are built to be extremely sturdy. Made with especially strong steel tubing with three folding feet. The base and boom mount are made of indestructible die-cast zinc. The solid metal knobs are unlosable, to ensure that the stands survive the hard conditions of touring longer. The microphone stands are also faster to set up and take down. Turning the locking screw just 3/4 quickly snaps the boom into place. Height adjustment is just as easy, with incredibly quick tightening of the easy-grip, triangular tightening sleeve.

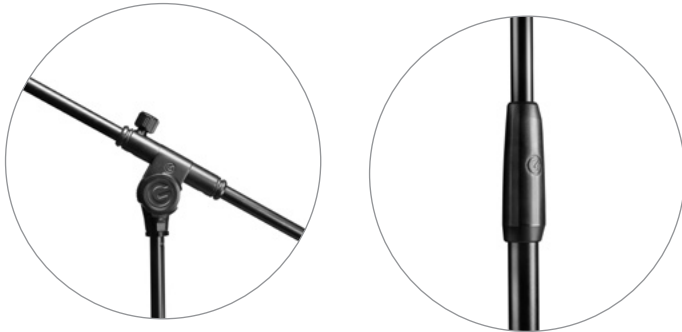

Product number	GTMS4321B
Product type	Stands and tripods
Type	Microphone stands
Tubing material	Steel
Colour	Black
Surface	Powder coated
Min. height	1030 mm
Max. height	1730 mm
Transport length	980 mm
Height adjustment	Yes
Base type	Tripod
Base material	Zinc die-cast
Boom model	2-point adjustment
Boom length	780 mm
Weight	3.6 kg

## TMS 4322 B

### TOURING SERIES TRIPOD MIC STAND WITH 2-POINT ADJUSTMENT TELESCOPING BOOM

The boom has an adjustment range of 51 to 88 cm. The screw-on counterweight has a specially designed locking nut for microphone clips. The solid metal knobs are unlosable, to ensure that the stands withstand the rigours of the road for longer.



Product number	GTMS4322B
Product type	Stands and tripods
Type	Microphone stands
Tubing material	Steel
Colour	Black
Surface	Powder coated
Min. height	1030 mm
Max. height	1730 mm
Transport length	980 mm
Height adjustment	Yes
Base type	Tripod
Base material	Zinc die-cast
Boom model	2-point adjustment
Telescoping	Yes
Boom length	510 - 880 mm
Weight	3.8 kg

# MICROPHONE STANDS

## MS 5311 B

### TRAVELER MICROPHONE STAND

Every bit of weight counts when you're travelling by plane or truck from one gig to the next. After all, you can't always rely on the concert venue having the right tool available for you when needed.

The Gravity® MS 5311 B microphone stand can be taken everywhere you go. It's so light, there's absolutely no need for you to worry about weight or availability.

Despite its light weight, the stand is still sturdy and strong. Its robust leg construction withstands heavy loads and gives the stand a solid foundation. The position and tilt of the boom can be adjusted quickly and easily at the joint with only one clamping screw. The handle, used for smoothly and securely adjusting the stand's height, and the clamping screw are made of exceptionally durable ABS plastic and covered with a non-slip soft-touch thermoplastic coating for comfortable operation.

Gravity® has once again delivered a useful and reliable product for you to round off your collection of stands.



Product number	GMS5311B
Product type	Stands and tripods
Type	Microphone stands
Material	Steel
Colour	Black
Surface	Powder coated
Min. height	950 mm
Max. height	1630 mm
Transport length	935 mm
Height adjustment	Yes
Base type	Tripod
Boom model	1-point adjustment
Boom length	790 mm
Interchangeable rings	2 x 15 mm , 1 x 25 mm
Black ring pack included	Yes
Weight	1.74 kg





## MS 431 HB

### MICROPHONE STAND WITH FOLDING TRIPOD AND ONE-HAND CLUTCH

The MS 431 HB is a premium quality microphone stand with thick walled tubing, powder coated finish and 179 cm maximum height. The heavy duty tripod base is made of die-cast zinc for an accurate fit of the ultra strong folding legs of steel with hefty rubber caps for surface protection. The MS 431 HB sports a slim, innovative clutch for convenient one-handed height adjustment. The ergonomic design and soft touch surface of the clutch handle provide a secure grip in all situations. The custom designed retainer requires no tools for quick and secure microphone clip attachment. A set of black coding rings is included with the MS 431 HB, additional ring packs are available in a wide array of colors for instant personalization.

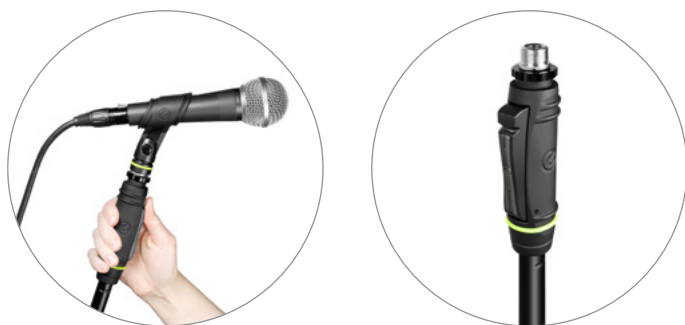

Product number	GMS431HB
Product type	Stands and tripods
Type	Microphone stands
Tubing material	Steel
Colour	Black
Surface	Powder coated
Min. height	1010 mm
Max. height	1790 mm
Transport length	1010 mm
Height adjustment	Yes
Base type	Tripod
Base material	Zinc die-cast
Interchangeable rings	1 x 15 mm, 4 x 20 mm
Black ring pack included	Yes
Weight	2.6 kg

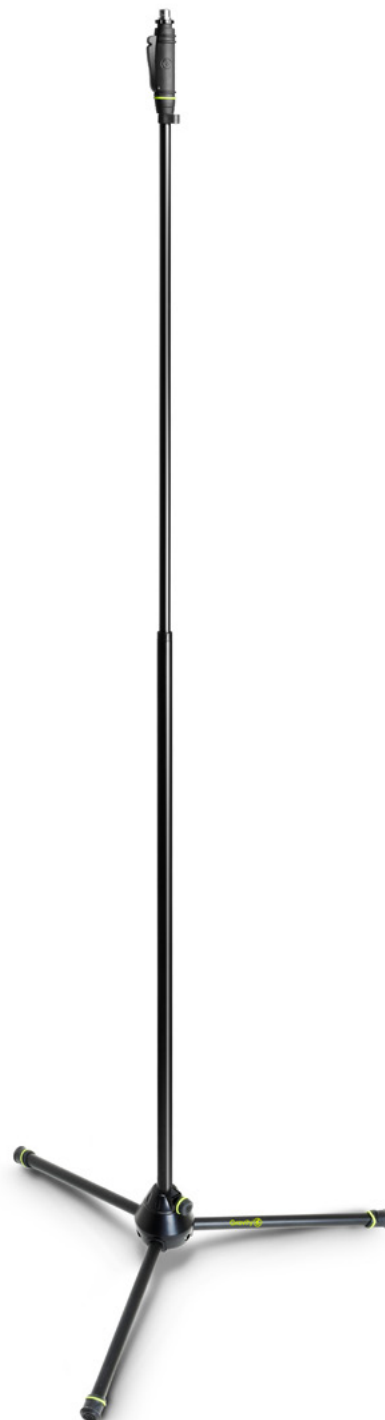

# MICROPHONE STANDS



**MS 43**  
MICROPHONE STAND WITH  
FOLDING TRIPOD BASE

Product number	GMS43
Product type	Stands and tripods
Type	Microphone stands
Tubing material	Steel
Colour	Black
Surface	Powder coated
Min. height	1030 mm
Max. height	1690 mm
Transport length	900 mm
Height adjustment	Yes
Base type	Tripod
Base material	Zinc die-cast
Interchangeable rings	1 x 15 mm, 4 x 20 mm
Black ring pack incl.	Yes
Weight	2.3 kg



**MS 43 DT B**  
COMPACT DOUBLE EXTENSION  
MICROPHONE STAND

Product number	GMS43DTB
Product type	Stands and tripods
Type	Microphone stands
Tubing material	Steel
Colour	Black
Surface	Powder coated
Min. height	700 mm
Max. height	1610 mm
Transport length	620 mm
Height adjustment	Yes
Base type	Tripod
Base material	Zinc die-cast
Interchangeable rings	3 x 15 mm, 3 x 20 mm
Black ring pack incl.	Yes
Weight	2.18 kg



**MS 4321 B**  
MICROPHONE STAND WITH  
FOLDING TRIPOD BASE AND  
2-POINT ADJUSTMENT BOOM

Product number	GMS4321B
Product type	Stands and tripods
Type	Microphone stands
Tubing material	Steel
Colour	Black
Surface	Powder coated
Min. height	1030 mm
Max. height	1690 mm
Transport length	1050 mm
Height adjustment	Yes
Base type	Tripod
Base material	Zinc die-cast
Boom model	2-point adjustment
Boom length	790 mm
Interchangeable rings	1 x 25 mm, 2 x 15 mm, 4 x 20 mm
Black ring pack incl.	Yes
Weight	2.7 kg



### MS 4322 HDB

HEAVY DUTY MICROPHONE STAND WITH FOLDING TRIPOD BASE AND 2-POINT ADJUSTMENT TELESCOPING BOOM

### MS 4322 B / MS 4322 W

MICROPHONE STAND WITH FOLDING TRIPOD BASE AND 2-POINT ADJUSTMENT TELESCOPING BOOM

### MS 4221 B

SHORT MICROPHONE STAND WITH FOLDING TRIPOD BASE AND 2-POINT ADJUSTMENT BOOM

Product number	GMS4322HDB
Product type	Stands and tripods
Type	Microphone stands
Tubing material	Steel
Colour	Black
Surface	Powder coated
Min. height	1030 mm
Max. height	1690 mm
Transport length	1050 mm
Height adjustment	Yes
Base type	Tripod
Base material	Zinc die-cast
Boom model	2-point adjustment
Boom length	510 - 880 mm
Interchangeable rings	1 x 25 mm, 4 x 20 mm, 2 x 15 mm
Black ring pack incl.	Yes
Weight	4.26 kg

Product number	GMS4322B / W
Product type	Stands and tripods
Type	Microphone stands
Tubing material	Steel
Colour	Black / white
Surface	Powder coated
Min. height	1030 mm
Max. height	1690 mm
Transport length	1050 mm
Height adjustment	Yes
Base type	Tripod
Base material	Zinc die-cast
Boom model	2-point adjustment
Boom length	510 - 880 mm
Interchangeable rings	2 x 15 mm, 4 x 20 mm, 1 x 25 mm
Black ring pack included	Yes
Weight	2.7 kg

Product number	GMS4221B
Product type	Stands and tripods
Type	Microphone stands
Tubing material	Steel
Colour	Black
Surface	Powder coated
Min. height	510 mm
Max. height	740 mm
Transport length	600 mm
Height adjustment	Yes
Base type	Tripod
Base material	Zinc die-cast
Boom model	2-point adjustment
Boom length	500 mm
Interchangeable rings	2 x 15 mm, 1 x 25 mm, 4 x 20 mm
Black ring pack included	Yes
Weight	2.2 kg

# MICROPHONE STANDS



## MS 4222 B

SHORT MICROPHONE STAND WITH FOLDING TRIPOD BASE AND 2-POINT ADJUSTMENT TELESCOPING BOOM

Product number	GMS4222B
Product type	Stands and tripods
Type	Microphone stands
Tubing material	Steel
Colour	Black
Surface	Powder coated
Min. height	510 mm
Max. height	740 mm
Transport length	650 mm
Height adjustment	Yes
Base type	Tripod
Base material	Zinc die-cast
Boom model	2-point adjustment
Boom length	510 - 880 mm
Interchangeable rings	2 x 15 mm, 4 x 20 mm, 1 x 25 mm
Black ring pack included	Yes
Weight	2.2 kg

## MS 3122 HDB

SHORT HEAVY DUTY MICROPHONE STAND WITH FOLDING TRIPOD BASE

Product number	GMS3122HDB
Product type	Stands and tripods
Type	Microphone stands
Tubing material	Steel
Colour	Black
Surface	Powder coated
Max. height	320 mm
Transport length	500 mm
Height adjustment	No
Base type	Tripod
Base material	Zinc die-cast
Boom model	2-point adjustment
Boom length	510 - 880 mm
Interchangeable rings	1 x 25 mm, 2 x 15 mm, 3 x 20 mm
Black ring pack included	Yes
Weight	2.84 kg



# TURN ANY PLACE INTO YOUR STAGE



reddot winner 2024

## ANNY® SERIES

PORTABLE BATTERY-POWERED PA SYSTEMS

ANNY® - your battery-powered sound solution for truly anywhere: in the city, in the garden, at gatherings, at sports events, at school and dance events, in bars, at parties. Wherever you are, ANNY® provides professional sound and creates unforgettable moments.

With a wide range of inputs, ANNY® enables a variety of setups with a mix of speech and music. With ANNY® at your side, you'll create a great atmosphere and professional sound - wherever you are. So go ahead and turn any place into your stage.



[ld-systems.com/ANNY](https://ld-systems.com/ANNY)

DESIGNED & ENGINEERED IN GERMANY  
LD Systems® is a registered brand of the Adam Hall Group.

LDsystems 

# MICROPHONE STANDS

## MS 231 HB

### MICROPHONE STAND WITH ROUND BASE AND ONE-HAND CLUTCH

The MS 231 HB is a premium quality microphone stand with thick walled tubing, powder coated finish and 175 cm maximum height. Made of cast iron, the heavy duty round base features a rubber ring at the bottom for acoustic isolation and surface protection. The MS 231 HB sports a slim, innovative clutch for convenient one-handed height adjustment. The ergonomic design and soft touch surface of the clutch handle provide a secure grip in all situations. The custom designed retainer requires no tools for quick and secure microphone clip attachment. A set of black coding rings is included with the MS 231 HB, additional ring packs are available in a wide array of colors for instant personalization. For increased stability we offer a 2.3 kg add-on weight plate that installs without tools (part no. MS 2 WP).



Product number	GMS231HB
Product type	Stands and tripods
Type	Microphone stands
Tubing material	Steel
Colour	Black
Surface	Powder coated
Min. height	1080 mm
Max. height	1750 mm
Transport length	1080 mm
Height adjustment	Yes
Base type	Round base
Base material	Cast iron
Base diameter	270 mm
Base weight	3.6 kg
Interchangeable rings	1 x 20 mm
Black ring pack included	Yes
Weight	4.4 kg

## XSP 1062

### COUNTER NUT 3/8"



## MS 23 XLR B

### MICROPHONE STAND WITH XLR CONNECTOR AND GOOSENECK

Enabling ultra flexible microphone orientation, this premium quality stand features a 36.5 cm gooseneck on a thick walled 114.5 cm tube and a heavy duty round base made of cast iron. The gooseneck integrates a 3-pin female XLR connector for directly attaching a microphone while the tube sports a lateral XLR mic cable connector at the bottom end. This permits quick, clean setup without mic clips and running the cable up the stand. To extend the stand's height and increase stability, additional XLR goosenecks (item no. XSP 10175) and a weight disc (item no. MS 2 WP) are available as accessories.

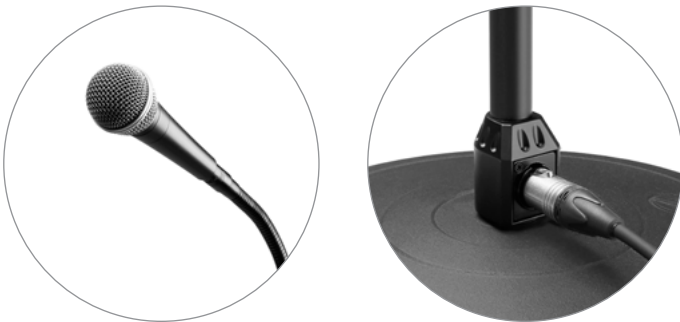

Product number	GMS23XLRB
Product type	Stands and tripods
Type	Microphone stands
Tubing material	Steel
Colour	Black
Surface	Powder coated
Min. height	1080 mm
Max. height	1510 mm
Transport length	1080 mm
Height adjustment	Yes
Base type	Round base
Base material	Cast iron
Base diameter	270 mm
Base weight	3.6 kg
Weight	4.3 kg





# MICROPHONE STANDS



**MS 23 / W**  
MICROPHONE STAND WITH  
ROUND BASE

Product number	GMS23 / W
Product type	Stands and tripods
Type	Microphone stands
Tubing material	Steel
Colour	Black / white
Surface	Powder coated
Min. height	1000 mm
Max. height	1600 mm
Transport length	1000 mm
Height adjustment	Yes
Base type	Round base
Base material	Cast iron
Base diameter	270 mm
Base weight	3.6 kg
Interchangeable rings	1 x 20 mm
Black ring pack incl.	Yes
Weight	4.2 kg



**MS 2321 B**  
MICROPHONE STAND WITH  
ROUND BASE AND 2-POINT  
ADJUSTMENT BOOM

Product number	GMS2321B
Product type	Stands and tripods
Type	Microphone stands
Tubing material	Steel
Colour	Black
Surface	Powder coated
Min. height	1000 mm
Max. height	1680 mm
Transport length	1000 mm
Height adjustment	Yes
Base type	Round base
Base material	Cast iron
Base diameter	270 mm
Base weight	3.6 kg
Boom model	2-point adjustment
Boom length	790 mm
Interchangeable rings	1 x 20 mm, 1 x 15 mm, 1 x 25 mm
Black ring pack incl.	Yes
Weight	4.8 kg



**MS 2322 B**  
MICROPHONE STAND WITH ROUND  
BASE AND 2-POINT ADJUSTMENT  
TELESCOPING BOOM

Product number	GMS2322B
Product type	Stands and tripods
Type	Microphone stands
Tubing material	Steel
Colour	Black
Surface	Powder coated
Min. height	1000 mm
Max. height	1680 mm
Transport length	1050 mm
Height adjustment	Yes
Base type	Round base
Base material	Cast iron
Base diameter	270 mm
Base weight	3.6 kg
Boom model	2-point adjustment
Boom length	510 - 880 mm
Interchangeable rings	1 x 15 mm, 1 x 20 mm, 1 x 25 mm
Black ring pack incl.	Yes
Weight	4.8 kg





## MS 2222 B

SHORT MICROPHONE STAND  
WITH ROUND BASE AND 2-POINT  
ADJUSTMENT TELESCOPING BOOM

Product number	GMS2222B
Product type	Stands and tripods
Type	Microphone stands
Tubing material	Steel
Colour	Black
Surface	Powder coated
Min. height	480 mm
Max. height	730 mm
Transport length	550 mm
Height adjustment	Yes
Base type	Round base
Base material	Cast iron
Base diameter	270 mm
Base weight	3.6 kg
Boom model	2-point adjustment
Boom length	510 - 880 mm
Interchangeable rings	1 x 15 mm, 1 x 20 mm, 1 x 25 mm
Black ring pack incl.	Yes
Weight	4 kg



## MS T 01 B

TABLE-TOP MICROPHONE  
STAND

Product number	GMST01B
Product type	Stands and tripods
Type	Microphone stands
Tubing material	Steel
Colour	Black
Surface	Powder coated
Height	200 mm
Base material	Cast iron
Base diameter	130 mm
Boom	No
Weight	1.26 kg



## MS 0200 / SET1

MICROPHONE POLE FOR TABLE  
MOUNTING INCL. TABLE CLAMP  
AND BOOM

Product number	GMS0200SET1
Product type	Stands and tripods
Type	Microphone accessories
Weight	0.96 kg
<b>Product number</b>	<b>GMS0200</b>
Product type	Stands and tripods
Type	Microphone accessories
Tubing material	Steel
Colour	Black
Surface	Powder coated
Min. height	370 mm
Max. height	600 mm
Transport length	370 mm
Height adjustment	Yes
Interchangeable rings	1 x 20 mm
Black ring pack included	Yes
Weight	0.36 kg
<b>Product number</b>	<b>GMSTM1B</b>
Product type	Microphone accessories
Type	Microphone holder
Colour	Black
Material	Steel
Surface	Powder coated
Threaded connector	3/8"
For table top thickness	Up to 45 mm
Weight	0.19 kg
<b>Product number</b>	<b>GMSB22</b>
Product type	Stands and tripod accessories
Tube material	Steel
Colour	Black
Surface	Powder coated
Boom length	500 - 880 mm
Telescoping	Yes
Boom model	2-point adjustment
Interchangeable rings	1 x 15 mm , 1 x 25 mm
Black ring pack included	Yes
Weight	0.43 kg

# MICROPHONE STANDS



## MS CAB CL 01

CAB CLAMP MICROPHONE HOLDER  
FOR GUITAR CABINETS

Product number	GMSCABCL01
Product type	Microphone accessories
Type	Microphone holder
Material	Aluminum
Surface	Powder coated
Colour	Black
Clamping width	265 - 400 mm
Extension length	250 mm
Threaded connector	3/8"
Weight	0.6 kg



## MS CAB CL 01 S

CAB CLAMP - MIC HOLDER FOR GUITAR CABS  
SHORT VERSION

Product number	GMSCABCL01S
Product type	Microphone accessories
Type	Microphone holder
Material	Aluminum
Surface	Powder coated
Colour	Black
Clamping width	200 - 300 mm
Extension length	250 mm
Threaded connector	3/8"
Weight	0.51 kg



Compatibility list  
[gravitystands.com/MS-CAB-CL-01-S](http://gravitystands.com/MS-CAB-CL-01-S)

# ACCESSORIES MICROPHONE STANDS

## MA POP 1

### POP FILTER WITH VARI®-ARM

To make sure your pop filter successfully filters undesired pop noises and clipping, you need to be able to position it perfectly in front of your mouth. This is simple with the Gravity® MA POP 1 pop filter, with its large screen diameter, double nylon mesh and VARI®-ARM.

The VARI®-ARM allows you to position the pop filter precisely where it will work best, and then fix into position so that it won't shift.

All joints can be moved using only one single adjustment screw. Once the desired position has been achieved, you simply tighten the screw to fix the whole VARI®-ARM. This way, your pop filter won't slip out of position while you're sitting at your desk creating a podcast or standing in the studio booth recording vocals.

The solid clamp fits on any microphone stand, on the edge of a table or any other surface you want to attach it within the clamping range of 15 mm to 35 mm.



Product number	GMAPOP1
Product type	Microphone accessories
Type	Pop filter
Material VARI®-ARM	Steel
Colour	Black
Mounting	Microphone stand, tabletop
Screen diameter	157 mm
Setup	Double nylon screen, plastic frame
Fits tube diameters up to	15 mm to 35 mm
Weight	0.5 kg



reddot winner 2021



# ACCESSORIES MICROPHONE STANDS

## TRAVELER SERIES



### MA 3D A

TRAVELER 3D ARM

Product number	GMA3DA
Product type	Stands and tripods
Type	Other stands and tripods
Material	Polyamid synthetic material
Joint adjustment	Wing screw
Joint rotation	360°
Joint tilt	180°
Arm length max.	400 mm
Suitable for mounting on	Microphone stands
Suitable for tube diameter	15 mm - 35 mm
Colour	Black
Thread	3/8"
Weight	0.3 kg



### MA 3D A POP 1

TRAVELER 3D ARM WITH POP FILTER

Product number	GMA3DAPOP1
Product type	Microphone accessories
Type	Pop filter
Material	Plastic, polyamide
Colour	Black
Joint adjustment	Wing screw
Joint rotation	360°
Joint tilt	180°
Arm length	400 mm
Suitable for mounting on	Microphone stands
Thread size	3/8"
Screen diameter	157 mm
Setup	Double nylon screen, plastic frame
Fits tube diameters up to	15 mm - 35 mm
Weight	0.38 kg



### MA DSB 01

TRAVELER DRUMSTICK HOLDER

Product number	GMADSB01
Product type	Stands and tripod accessories
Material basket	Polyester
Material arm and Clamp	Polyamid synthetic material
Colour	Black
Suitable for mounting on	Drumhardware; microphone stands
Basket diameter	100 mm
Basket height	250 mm
Arm length	110 mm
Joint adjustment	Wing screw
Joint rotation	360°
Joint tilt	180°
Suitable for tube diameter	15 mm - 35 mm
Weight	0.25 kg

POLES ARE NOT INCLUDED



## MA TE 01

### TRAVELER EXTENSION

Product number	GMATE01
Product type	Stands and tripods
Type	Other Stands and tripods
Material	Plastic, polyamide
Colour	Black
Length	100 mm
Weight	0.08 kg



## NS MS 02

### TRAVELER SHEET MUSIC HOLDER

Product number	GNSMS02
Product type	Stands and tripods
Type	Music stand
Support material	Steel
Arm and clamp material	Polyamid synthetic material
Colour	Black
Suitable for mounting on	Microphone stands
Support surface	Powder coated
Support width	220 mm
Support height	310 mm
Arm length	110 mm
Joint adjustment	Wing screw
Joint rotation	360°
Joint tilt	180°
Suitable for tube diameter	15 mm - 35 mm
Weight	0.8 kg



## NS MS 03

### FOLDABLE TRAVELER SHEET MUSIC HOLDER

Product number	GNSMS03
Product type	Stands and tripods
Music desk type	Folding
Support material	Steel
Support surface	Powder coated
Support width	465 mm
Support height	235 mm
Material arm and Clamp	Polyamid synthetic material
Arm length	110 mm
Joint adjustment	Wing screw
Joint rotation	360°
Joint tilt	180°
Suitable for mounting on	Microphone stands
Suitable for tube diameter	15 mm - 35 mm
Colour	Black
Weight	0.6 kg



## MA TRAY 3

### TILTABLE TRAVELER TRAY

Product number	GMATRAY3
Product type	Stands and tripod accessories
Material	Polyamid synthetic material
Material tilt adjustment	Steel
Colour	Black
Suitable for mounting on	Microphone stands; guitar stands
Support width	220 mm
Support depth	145 mm
Shelf tilt up to	180°
Clamp length from - to	52 mm - 70 mm
Suitable for tube diameter	15 mm - 35 mm
Weight	0.26 kg

POLES ARE NOT INCLUDED

# ACCESSORIES MICROPHONE STANDS

## NS MS 01

### MUSIC STAND DESK FOR MICROPHONE STANDS

This simple but smart adaptation of a music stand desk allows you to convert any microphone stand into a music stand. This music desk is equipped with a 3/8" female thread and can be attached to any product with a male counterpart thread. The desk can thus also be attached to various kinds of mic holders such as table-top or conventional stands – opening a whole new world of options.

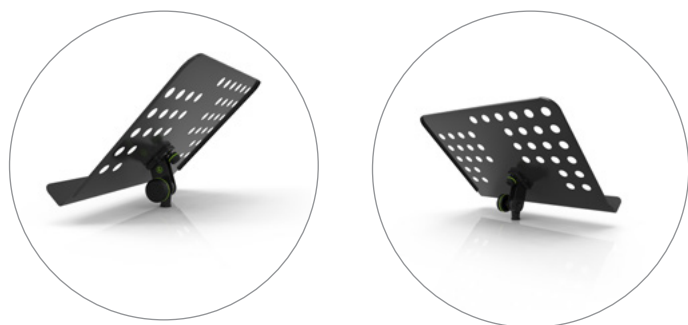

Product number	GNSMS01
Product type	Stands and tripods
Type	Music stand
Music desk type	Perforated music desk
Support material	Steel
Surface	Powder coated
Colour	Black
Width	340 mm
Height	475 mm
Weight	1.8 kg

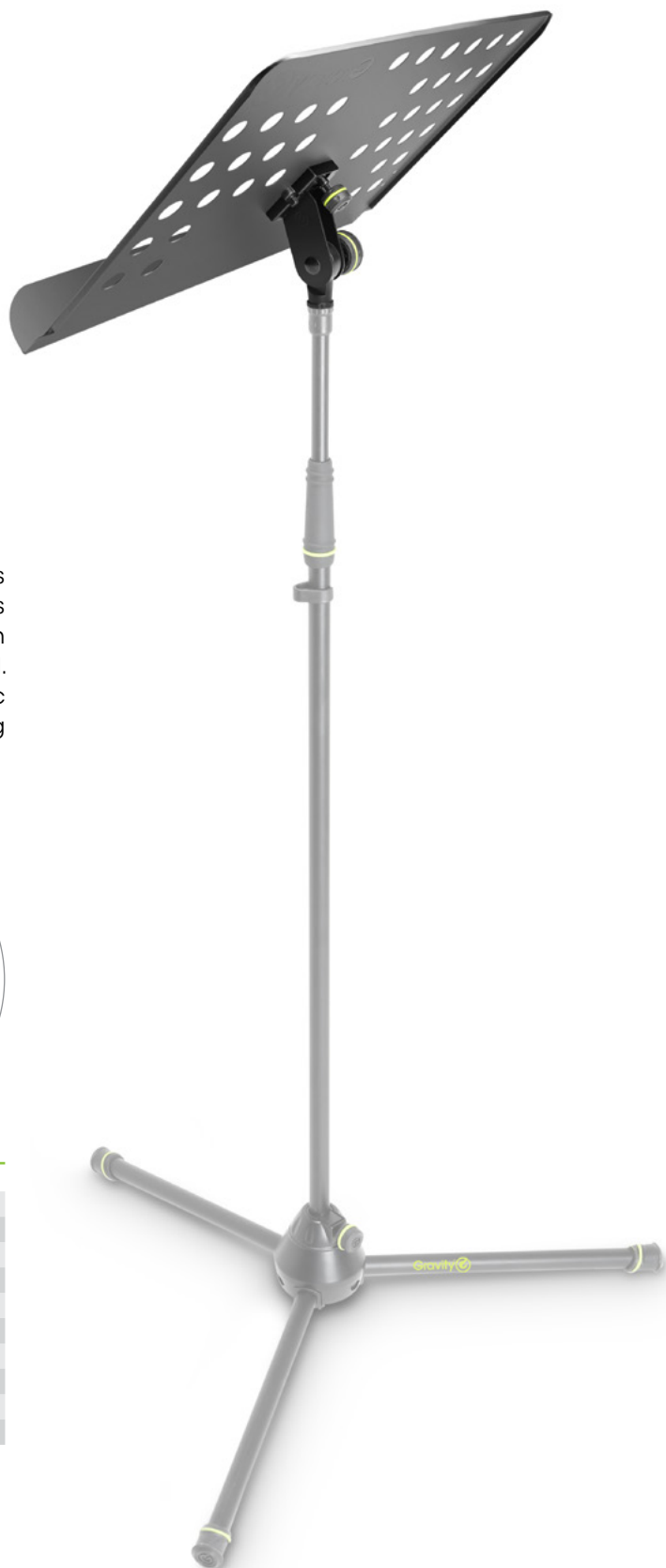



## MSTM 1 B

### MICROPHONE TABLE CLAMP



Product number	GMSTM1B
Product type	Microphone accessories
Type	Microphone holder
Colour	Black
Material	Steel
Surface	Powder coated
Threaded connector	3/8"
For table top thickness	Up to 45 mm
Interchangeable rings	1 x 15 mm
Weight	0.19 kg



## MA GOOSE XL

### GOOSENECK EXTRA LONG 600 MM

Product number	GMAGOOSXL
Product type	Goosenecks, stands and tripods
Type	Goosenecks
Material	Steel
Colour	Black
Connector 1	3/8" thread male
Connector 2	3/8" thread female
Length	600 mm
Diameter	15 mm
Weight	0.47 kg

## MA GOOSE L

### GOOSENECK LONG 460 MM

Product number	GMAGOOSL
Product type	Goosenecks, stands and tripods
Type	Goosenecks
Material	Steel
Colour	Black
Connector 1	3/8" thread male
Connector 2	3/8" thread female
Length	460 mm
Diameter	15 mm
Weight	0.39 kg

## MA GOOSE M

### GOOSENECK MEDIUM 320 MM

Product number	GMAGOOSEM
Product type	Goosenecks, stands and tripods
Type	Goosenecks
Material	Steel
Colour	Black
Connector 1	3/8" thread male
Connector 2	3/8" thread female
Length	320 mm
Diameter	15 mm
Weight	0.26 kg

## MA GOOSE S

### GOOSENECK SHORT 140 MM

Product number	GMAGOOSSE
Product type	Goosenecks, stands and tripods
Type	Goosenecks
Material	Steel
Colour	Black
Connector 1	3/8" thread male
Connector 2	3/8" thread female
Length	140 mm
Diameter	15 mm
Weight	0.12 kg

# ACCESSORIES MICROPHONE STANDS

## MS B 21

### 2-POINT ADJUSTMENT BOOM ARM

This 80 cm boom arm features a cast aluminum hub with precision 2-point tilt and position adjustment and 3/8" male thread. The ergonomic set screw knobs are made from high-grade ABS with a soft touch, non-slip thermoplastic coating for comfortable operation.



Product number	GMSB21
Product type	Stands and tripod accessories
Material	Steel
Colour	Black
Surface	Powder coated
Boom length	800 mm
Interchangeable rings	1 x 15 mm, 1 x 25 mm
Black ring pack included	Yes
Weight	0.4 kg

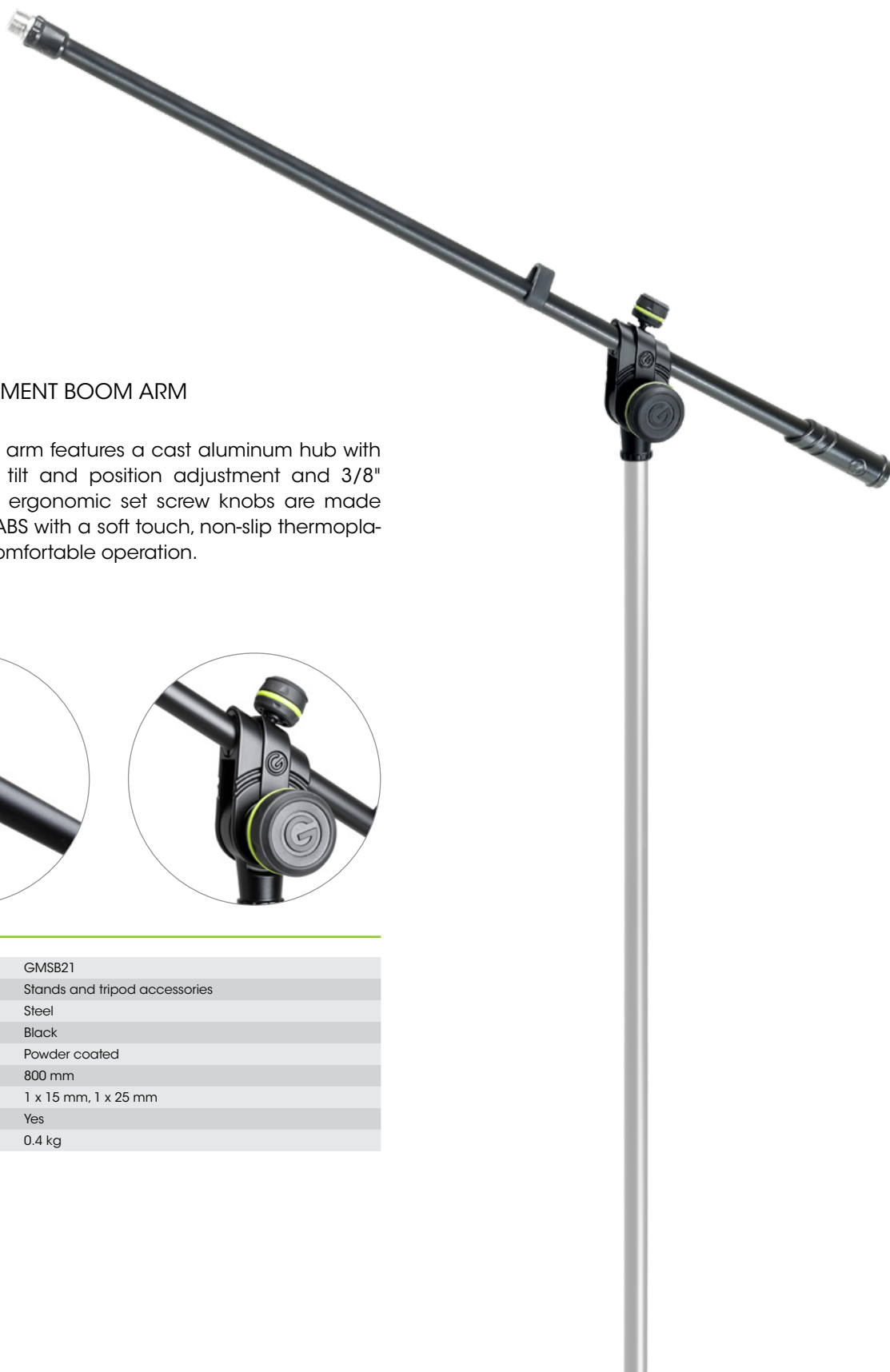

## MS B 22 / MS W 22

### 2-POINT ADJUSTMENT TELESCOPING BOOM ARM

This telescoping boom arm features a cast aluminum hub with precision 2-point tilt and position adjustment and 3/8" male thread. The ergonomic set screw knobs are made from high-grade ABS with a soft touch, non-slip thermoplastic coating for comfortable operation. A convenient quick fastener allows for variable extension to a maximum length of 88 cm facilitating flexible mic placement.



Product number	GMSB22 / GMSW22
Product type	Stands and tripod accessories
Material	Steel
Colour	Black / white
Surface	Powder coated
Boom length	500 - 880 mm
Telescoping	Yes
Boom model	2-point adjustment
Interchangeable rings	1 x 15 mm, 1 x 25 mm
Black ring pack included	Yes
Weight	0.43 kg

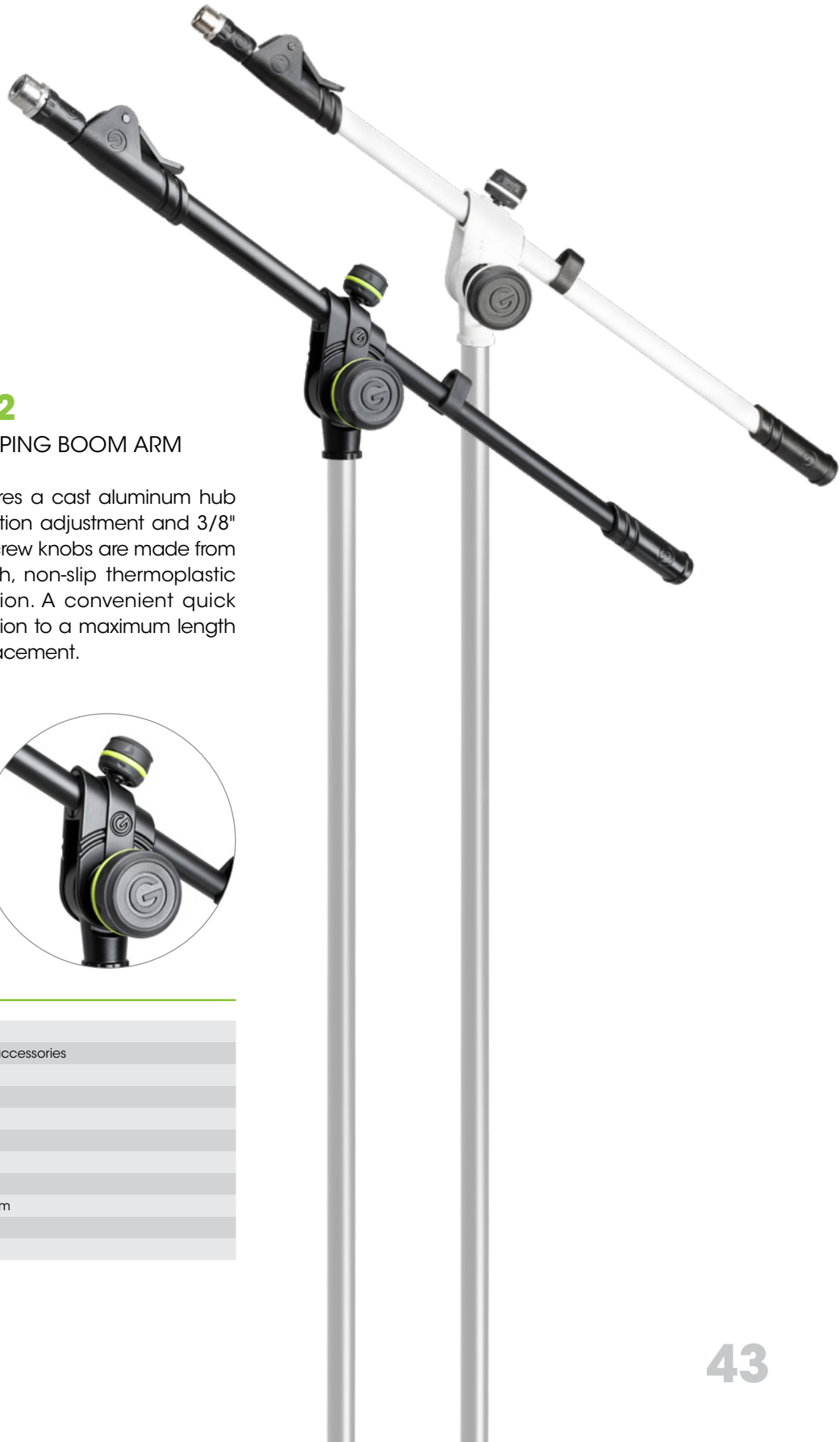

# ACCESSORIES MICROPHONE STANDS

Patented  
VARI®-Weight stability system



## MS 2 WP

### WEIGHT PLATE FOR ROUND BASE MICROPHONE STANDS

At 2.3 kg this cast iron weight plate can be attached to all round base Gravity® microphone stands without the need for tools, providing increased stability. VARI®-Weight - patented stability system for secure holding and simple transportation by means of an insertable weight plate. Round base not included in delivery.

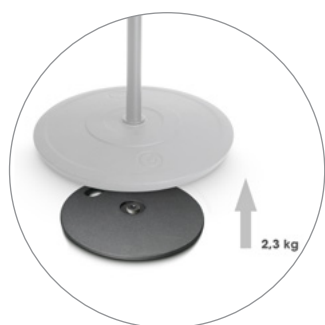

Product number	GMS2WP
Product type	Stands and tripod accessories
Material	Cast iron
Colour	Black
Surface	Powder coated
Diameter	210 mm
Weight	2.3 kg





## XSP 10129

### HOLDER FOR WB 123 WPB WEIGHT PLATES

Speaker stands with a round base, such as the Gravity® SSP WB SET 1, save space when set up and can be fitted with an additional weight plate to provide an even more stable stand. In order to mount the 5 kg WB 123 WPB weight plate firmly on the underside of the base plate, Gravity® has developed an additional retaining cross that provides even more stable securing than the enclosed mounting brackets.

The cross-shaped bracket made of steel convinces with its robust and durable construction. At the same time, it ensures optimal fastening by screwing it to the base plate and prevents the optional weight plate from accidentally falling out.

Product number	GXSP10129
Product type	Stands and tripod accessories
Type	Bracket for weight plates
Colour	Black
Material	Steel
Surface	Powder coated
Dimensions	380 x 380 mm
Weight	0.44 kg

# ACCESSORIES MICROPHONE STANDS



## MA SPACE 38 S

ROBUST STEEL EXTENSION ROD WITH 3/8" THREAD 50 MM

The Gravity® MA SPACE 38 S is made of sturdy steel, 50 mm long and suitable for extending any equipment with a 3/8" thread. It is easily attached in no time and can also be combined with other spacers. The possibilities are almost unlimited.



Product number	GMASPACE38S
Product type	Stands and tripod accessories
Colour	Black
Material	Steel
Surface	Powder coated
Threaded connector 1	3/8" male
Threaded connector 2	3/8" female
Tube length	50 mm
Length	60 mm
Weight	0.07 kg



## MA SPACE 38 M

ROBUST STEEL EXTENSION ROD WITH 3/8" THREAD, 100 MM

The Gravity® MA SPACE 38 M is made of sturdy steel, 100 mm long and suitable for extending any equipment with a 3/8" thread. It is easily attached in no time and can also be combined with other spacers. The possibilities are almost unlimited.



Product number	GMASPACE38M
Product type	Stands and tripod accessories
Colour	Black
Material	Steel
Surface	Powder coated
Threaded connector 1	3/8" male
Threaded connector 2	3/8" female
Tube length	100 mm
Length	110 mm
Weight	0.09 kg



## MA SPACE 38 L

ROBUST STEEL EXTENSION ROD WITH 3/8" THREAD, 300 MM

The Gravity® MA SPACE 38 L is made of sturdy steel, 300 mm long and suitable for extending any equipment with a 3/8" thread. It is easily attached in no time and can also be combined with other spacers. The possibilities are almost unlimited.



Product number	GMASPACE38L
Product type	Stands and tripod accessories
Colour	Black
Material	Steel
Surface	Powder coated
Threaded connector 1	3/8" male
Threaded connector 2	3/8" female
Tube length	300 mm
Length	310 mm
Weight	0.17 kg

## MA DRINK M

### MEDIUM DRINK HOLDER FOR MICROPHONE STANDS

This drink holder features a unique screw clamp that is adjustable for vertical or horizontal mounting options. It fits on mic stands, speaker stands and music stands with tubing diameters up to 35 mm as well as table tops and securely holds bottles, cans, cups and glasses with a maximum diameter of 78 mm.

Product number	GMADRINKM
Product type	Microphone accessories
Type	Drink holder
Material	Plastic, steel
Colour	Black
Suitable for tube diameter	Up to 35 mm
Inner diameter	78 mm
Width	87 mm
Height	102 mm
Interchangable rings	1 x 15 mm
Black ring pack included	Yes
Weight	0.16 kg



## MA DRINK L

### LARGE DRINK HOLDER FOR MICROPHONE STANDS

Product number	GMADRINKL
Product type	Microphone accessories
Type	Drink holder
Material	Plastic, steel
Colour	Black
Suitable for tube diameter	Up to 35 mm
Inner diameter	100 mm
Width	110 mm
Height	135 mm
Interchangable rings	1 x 15 mm
Black ring pack included	Yes
Weight	0.18 kg

78 mm inner diameter



100 mm inner diameter



# ACCESSORIES MICROPHONE STANDS

## MA DRINK M TC

### MEDIUM DRINK HOLDER WITH TABLE CLAMP

Introducing the Gravity® Table Drink Holder - the perfect solution for keeping your drinks close and within reach at all times. With its secure hold and adjustable design, this cup holder is a must-have for any table top.

The MA DRINK M TC clamp features a clamping-range of 45 mm and thanks to its 90° adjustment option, the Gravity® Table Drink Holder can be attached to your table or the sides of your shelf - horizontally or vertically.

Featuring a sleek and modern design, the Gravity® Table Drink Holder is a stylish addition to any table. Its sturdy construction and secure hold ensure that your favorite bottles, cans, mugs, and glasses - with up to 78 mm diameter - stay firmly in place, so you can enjoy your drinks without worrying about spills or mess.

Product number	GMADRINKMTC
Product type	Stands and tripod accessories
Type	Drink holder
Material	Plastic, steel
Colour	Black
Clamping range up to	45 mm
Inner diameter	78 mm
Width	87 mm
Height	102 mm
Interchangeable rings	1 x 15 mm
Black ring pack included	Yes
Weight	0.22 kg



## MA DRINK LTC

### LARGE DRINK HOLDER WITH TABLE CLAMP

Product number	GMADRINKLTC
Product type	Stands and tripod accessories
Type	Drink holder
Material	Plastic, steel
Colour	Black
Clamping range up to	45 mm
Inner diameter	100 mm
Width	110 mm
Height	135 mm
Interchangeable rings	1 x 15 mm
Black ring pack included	Yes
Weight	0.26 kg







## MA TRAY 1

MICROPHONE STAND TRAY 250 MM X 195 MM

Product number	GMATRAY1
Product type	Stands and tripod accessories
Material	Steel
Colour	Black
Suitable for mounting on	Microphone stand
Support width	250 mm
Support depth	195 mm
Extension Length	200 mm
Interchangeable rings	1 x 20 mm
Black ring pack included	Yes
Weight	1.1 kg

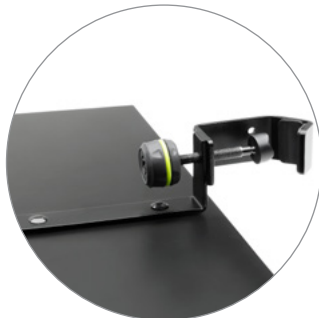

## MA TRAY 2

MICROPHONE STAND TRAY 400 MM X 130 MM

Product number	GMATRAY2
Product type	Stands and tripod accessories
Material	Steel
Colour	Black
Suitable for mounting on	Microphone stand
Support width	400 mm
Support depth	130 mm
Extension Length	50 mm
Interchangeable rings	1 x 15 mm
Black ring pack included	Yes
Weight	0.4 kg



# ACCESSORIES MICROPHONE STANDS



**MS U CLMP**  
UNIVERSAL MICROPHONE  
CLAMP FOR HANDHELD  
MICROPHONES



Product number	GMSUCLMP
Product type	Microphone accessories
Type	Microphone clip
Material	Plastic
Threaded connector	5/8"
Microphone mount (diameter)	14 - 42 mm
Joint	Screw-on
Features	3/8" adapter
Interchangeable rings	2 x 15 mm
Black ring pack included	Yes
Weight	0.08 kg



**MS CLMP 34**  
MICROPHONE CLAMP 34MM



Product number	GMSCCLMP34
Product type	Microphone accessories
Type	Microphone clip
Material	Plastic
Threaded connector	5/8"
Microphone mount (diameter)	34 - 42 mm
Joint	Screw-on
Features	3/8" adapter
Interchangeable rings	1 x 15 mm
Black ring pack included	Yes
Weight	0.06 kg



**MS CLMP 25**  
MICROPHONE CLAMP 25MM



Product number	GMSCCLMP25
Product type	Microphone accessories
Type	Microphone clip
Material	Plastic
Threaded connector	5/8"
Microphone mount (diameter)	24 - 35 mm
Joint	Screw-on
Features	3/8" adapter
Interchangeable rings	1 x 15 mm
Black ring pack included	Yes
Weight	0.05 kg



## MS STB 01

STEREO BAR FOR 2 MICROPHONES 60 - 170MM



Product number	GMSSTB01
Product type	Stands and tripod accessories
Material	Aluminum
Colour	Black
Horizontal adjustment range	60 - 170 mm
Threaded connector	3/8"
Material thickness	4 mm
Length	190 mm
Interchangeable rings	2 x 15 mm
Black ring pack included	Yes
Weight	0.05 kg



## MS STB 02

STEREO BAR FOR 2 MICROPHONES 60 - 220MM

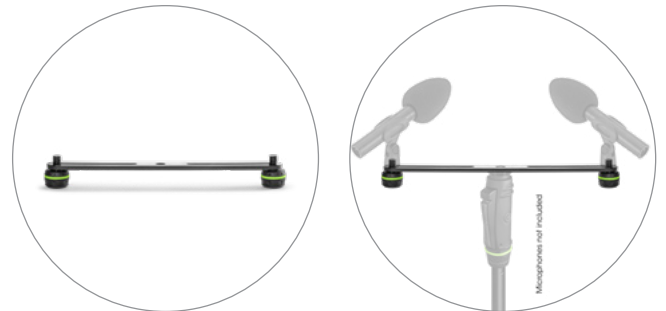

Product number	GMSSTB02
Product type	Stands and tripod accessories
Material	Aluminum
Colour	Black
Horizontal adjustment range	60 - 220 mm
Threaded connector	3/8"
Material thickness	4 mm
Length	248 mm
Interchangeable rings	2 x 15 mm
Black ring pack included	Yes
Weight	0.07 kg

# ACCESSORIES MICROPHONE STANDS



## MS STB 01 PRO

STEREO ARRAY MICROPHONE BAR

60 - 290 MM

Precise and repeatable arrangements of two microphones for stereo recordings are the specialty of the Gravity Stereo Bar. This real precision instrument allows the exact adjustment of the distance between the movable microphone holders from 6 to 29 cm, the microphone alignment on the horizontal axis by  $\pm 90^\circ$  and  $\pm 90^\circ$  inclination of the entire rail. Easy-to-read spacing and angle markings facilitate fast and precise positioning, taking notes of your settings and recreating them without effort. Set screws with ergonomic soft-touch knobs securely lock the adjustable parts in the desired position.

The Gravity® Stereo Mic Bar is suitable for common stereo recording techniques including ORTF, DIN, XY and AB patterns and mounts on any mic stand. It is engineered from strong yet lightweight aluminum and easily able to support two large diaphragm microphones.

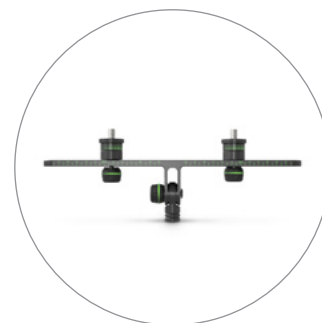

Product number	GMSSTB01PRO
Product type	Stands and tripod accessories
Material	Aluminum
Colour	Black
Horizontal adjustment range	60 - 290 mm
Threaded connector	3/8 "
Material thickness	8 mm
Swivel range	360 °
Tilt angle	-90 - +90 °
Length	330 mm
Weight	0.72 kg





## HP HMS 01 B

HEADPHONES HOLDER FOR MICROPHONE STAND



Product number	GPHMS01B
Product type	Microphone accessories
Type	Headphone holder
Material	Plastic / steel
Mounting	Microphone stand
Colour	Black
Support width	60 mm
Deck depth	100 mm
Suitable for tube diameter	Up to 30 mm
Interchangeable rings	1 x 15 mm
Black ring set included	Yes
Weight	0.18 kg



## MA MH 01

MICROPHONE HOLDER FOR MICROPHONE STAND



Product number	GMAMH01
Product type	Microphone accessories
Type	Headphone holder
Colour	Black
Material	Steel
Surface	Powder coated
Suitable for tube diameter	Up to 30 mm
Threaded connector	3/8"
Length	160 mm
Interchangeable rings	2 x 15 mm
Black ring pack included	Yes
Weight	0.14 kg

# ACCESSORIES MICROPHONE STANDS



## MS QC 1 B

QUICK COUPLER FOR MICROPHONE CLIPS & BOOM ARMS

Product number	GMSQC1B
Product type	Stands and tripod accessories
Material	Aluminum
Colour	Black
Surface	Powder coated
Height	90 mm
Thread stand	5/8"
Thread microphone	3/8"
Weight	0.13 kg



MSQC 1 TB  
Quick Coupler  
Crown  
individually  
available



## MS QT 1 B

QUICK-TILT MICROPHONE ADAPTER

Product number	GMSQT1B
Product type	Stands and tripod accessories
Colour	Black
Material	Aluminum
Surface	Powder coated
Threaded connector	3/8"
Length	55 mm
Interchangeable rings	1 x 15 mm
Black ring pack included	Yes
Weight	0.09 kg





## MS QT 2 B

### QUICK-TILT 1/4" ADAPTER

Product number	GMSQT2B
Product type	Stands and tripod accessories
Material	Aluminium
Surface	Powder coated
Colour	Black
Suitable for mounting on	Microphone stand
Threaded connector	1/4"
Length	55 mm
Interchangeable rings	1 x 15 mm
Black ring pack included	Yes
Weight	0.09 kg



## MS QT CAM 1 B

### QUICK-TILT CAMERA ADAPTER

Product number	GMSQTCAM1B
Product type	Stands and tripod accessories
Material	Aluminium
Colour	Black
Surface	Powder coated
Thread size 1 (inches)	1/4"
Thread size 2 (inches)	3/8" - 1/4"
Max load	3 kg
Interchangeable rings	1 x 15 mm
Black ring pack included	Yes
Weight	0.17 kg









# SPEAKER STANDS

Gravity® speaker stands use thick walled precision tubing, steel height adjustment collars and redesigned leg housings for maximum strength and durability. Air cushion and hand crank versions greatly facilitate lifting and lowering heavy loads, and our low-profile round base model provides an elegant, small footprint alternative to conventional tripods. In addition, the Gravity® range includes stands for your studio monitors, subwoofer poles and a selection of stand adapters.

# SPEAKER STANDS

## FEATURES



Sturdy, virtually indestructible steel collar with safety pin



Comfortable ergonomic knobs



Specially designed aluminum die-cast leg collar for superior strength



Crank operation for easy speaker raising and lowering

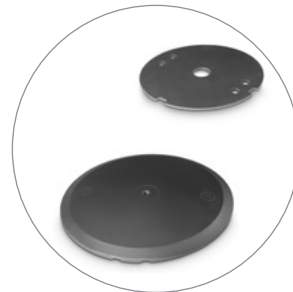

VARI®-Weight - Low-profile 9 kg cast iron base and a 5 kg weight plate which installs without tools



Tight, secure fit

## TSP 5212 LB

### TOURING SERIES STEEL SPEAKER STAND WITH AUTO LOCKPIN®

The hard conditions and extreme time pressures of touring are for strong workers and robust materials only - such as the Gravity® Touring series speaker stand. Extremely sturdy, with three double-braced legs and a die-cast aluminum mounting bracket. Especially strong steel tubing for a 50 kg load capacity. Set-up and take-down are extremely quick and safe thanks to the automatic, snap-in LockPin®. The 35 mm extension pole is locked into place and the pin can only be unlocked with the release lever. The loudspeaker stand can be adjusted to a height of up to 195 cm. The locking screws, with solid, unlosable metal knobs, are an invaluable advantage when touring.



Product number	GTSP5212LB
Product type	Stands and tripods
Type	Speaker stands
Tubing material	Steel
Colour	Black
Surface	Powder coated
Min height	1220 mm
Max height	1950 mm
Transport length	1140 mm
Height adjustment	Clamp with safety pin
Material of height adjustment	Steel
Base type	Leg joint
Base material	Die-cast aluminum
Tubing diameter	35 mm
Max. load	50 kg
Weight	6.4 kg



Get your tough stuff at [gravitystands.com/TOURINGSERIES](https://gravitystands.com/TOURINGSERIES)

# SPEAKER STANDS

## SP 5211 B / W - SP 5212 B

### SPEAKER STAND 35 MM

The SP 5211 is a classic tripod speaker stand made from thick walled, yet lightweight powder coated aluminum tubing with a load capacity of 50 kg and 195 cm maximum height. The die-cast aluminum leg collar has been completely redesigned to provide superior durability and longevity, the height adjustment collar is made of steel for additional strength and is virtually indestructible. It features a safety pin to securely lock the 35 mm diameter extension pole in place. The ergonomic set screw knobs are made from high grade ABS with a soft touch, non-slip thermoplastic coating for comfortable operation.

Product number	GSP5211B / W	GSP5212B
Product type	Stands and tripods	Stands and tripods
Type	Speaker stands	Speaker stands
Tubing material	Aluminum	Steel
Colour	Black / white	Black
Surface	Powder coated	Powder coated
Min height:	1060 mm	1060 mm
Max height	1950 mm	1950 mm
Transport length	1050 mm	1050 mm
Height adjustment	Clamp with safety pin	Clamp with safety pin
Material of height adjustment	Steel	Steel
Base type	Leg joint	Leg joint
Base material	Die-cast aluminum	Die-cast aluminum
Tubing diameter	35 mm	35 mm
Max. load	50 kg	50 kg
Interchangeable rings	5 x 30 mm	5 x 30 mm
Black ring pack included	Yes	Yes
Weight	2.2 kg	4.7 kg

Also available with steel tubing (SP 5212 B).





## SA CC 35 B

CABLE CLIPS SPEAKER POLE 35 MM



## SS 5212 B SET 1

SET OF 2 STEEL SPEAKER STANDS WITH BAG

## SS 5211 B SET 1

SET OF 2 ALUMINUM SPEAKER STANDS WITH BAG

Product number	GSS5212BSET1	GSS5211BSET1
Product type	Stands and tripods	Stands and tripod accessories
Type	Speaker stands	Speaker stands
Weight	10.4 kg	6 kg
<b>Gravity® transport bag</b>	<b>GBGSS2B</b>	<b>GBGSS2B</b>
Product type	Stands and tripod accessories	Stands and tripod accessories
Type	Transport bag	Transport bag
Number of stands	2	2
Type of stand	Speaker tripod	Speaker tripod
Colour	Black	Black
Material	Nylon 600D	Nylon 600D
Thickness of the padding	15 mm	15 mm
Latch	Double zip	Double zip
Dimensions (W x H x D)	1070 x 190 x 290 mm	1070 x 190 x 290 mm
Weight	0.52 kg	0.52 kg
<b>Gravity® speaker stands</b>	<b>GSP5212B</b>	<b>GSP5211B</b>
Product type	Stands and tripods	Stands and tripods
Type	Speaker stands	Speaker stands
Tubing material	Steel	Aluminum
Surface / Colour	Powder coated / black	Powder coated / black
Min. / max. height	1060 mm / 1950 mm	1060 mm / 1950 mm
Transport length	1050 mm	1050 mm
Height adjustment	Clamp with safety pin	Clamp with safety pin
Material of height adjustment	Steel	Steel
Base type / material	Leg joint / die-cast aluminum	Leg joint / die-cast aluminum
Tubing diameter	35 mm	35 mm
Max. load	50 kg	50 kg
Interchangeable rings	5 x 30 mm	5 x 30 mm
Black ring pack incl.	Yes	Yes
Weight	4.7 kg	2.2 kg

# SPEAKER STANDS

## TRAVELER SERIES

### SP 5112 B

#### TRAVELER SPEAKER STAND

The Gravity® SP 5112 B speaker stand can be taken everywhere you go. It's so light, there's absolutely no need for you to worry about weight or availability.

In addition to its lightness, the stand is stable, steady and offers you a load capacity of 15 kg at a maximum height of 120 cm. The compact leg construction and the slim extension tube with a diameter of just 25 mm not only allow the attachment of all other Traveler products that have the typical clamp, but also ensure an extremely small transport volume and thus give you the option of taking the stand with you everywhere you go. The height of the SP 5112 B is adjusted using Gravity's® signature screw knob, which is made of highly durable ABS with a non-slip soft-touch thermoplastic coating and is therefore extremely gentle for your hands.

Product number	GSP5112B
Product type	Stands and tripods
Type	Speaker stands
Tubing material	Aluminum
Colour	Black
Surface	Powder coated
Min. height	840 mm
Max. height	1205 mm
Transport length	690 mm
Height adjustment	Yes
Base type	Leg joint
Base material	Die-cast aluminum
Tubing diameter	35 mm
Max. load	15 kg
Interchangeable rings	5 x 30 mm
Black ring pack included	Yes
Weight	1.84 kg



## SP 5111 B

### SHORT ALUMINUM LOUDSPEAKER STAND 35 MM BLACK

If you want to set up your loudspeakers in a stable and secure way, or place your laptop in a firm and safe position, the SP 5111 B, as a short classic tripod loudspeaker stand, is exactly the right thing for you. It is made of sturdy but lightweight aluminum with black powder coating and can support up to 35 kg at a maximum height of 132 cm.

The Loudspeaker stand is excellent for attaching the Gravity® LTS TRAY 1 laptop tray and other 36 mm attachments that you need to use based on your body height.

Its mounting for the base is manufactured from die-cast aluminium. The steel sleeve for adjusting the height is virtually indestructible and offers additional stability. A locking pin holds the 35 mm thick extension tube in place. The ergonomic knobs for the set screws are made of highly durable ABS plastic and covered with a non-slip soft-touch thermoplastic coating for comfortable handling.

Thanks to its compact size and low weight of 1.94 kg, the short loudspeaker stand is perfect for portable use.

Product number	GSP5111B
Product type	Stands and tripods
Type	Speaker stands
Tubing material	Aluminum
Colour	Black
Surface	Powder coated
Min. height	950 mm
Max. height	1320 mm
Transport length	665 mm
Height adjustment	Adjusting screw with safety pin
Material of height adjustment	Steel
Base type	Leg joint
Base material	Die-cast aluminum
Tubing diameter	35 mm
Max. load	35 kg
Interchangeable rings	5 x 30 mm
Black ring pack included	Yes
Weight	1.94 kg



# SPEAKER STANDS

## SP 5522 B

### TWIN EXTENSION SPEAKER & LIGHTING STAND

The SP 5522 B is a classic tripod speaker and lighting stand made from thick walled, yet lightweight powder coated steel tubing with a load capacity of 30 kg and twin extensions for a maximum height of 3 m.

The die-cast aluminum leg collar has been completely redesigned to provide superior durability and longevity. The unbreakable height adjustment collars are made of steel for additional strength featuring safety pins to securely lock the extensions in place. The ergonomic set screw knobs are made from high grade ABS with a soft touch, non-slip thermoplastic coating for comfortable handling. A set of black coding rings is included with the SP 5522 B, additional ring packs are available in a wide array of colors for instant personalization.



Product number	GSP5522B
Product type	Stands and tripods
Type	Speaker stands
Tubing material	Steel
Colour	Black
Surface	Powder coated
Max. height	3000 mm
Min. height:	1110 mm
Height-adjustable	Yes
Material of height adjustment	Steel
Number of extensions	2
Thread stand	M10
Base type	Tripod
Base material	Die-cast aluminum
Tube diameter	35 mm
Max. load	30 kg
Interchangeable rings	5 x 30 mm
Black ring pack included	Yes
Weight	6.3 kg



## SP 5211 GS B

ALUMINUM SPEAKER STAND WITH GAS SPRING 35 MM  
BLACK

Raising and lowering your loudspeakers while being kind to your back - that's what the Gravity® SP 5211 GS B speaker stand with gas spring were made for.

The SP 5211 GS B is a classic tripod speaker stand made of strong but lightweight aluminium tubing. A gas spring is installed inside the stand, which lifts all conventional loudspeakers weighing up to 18 kg. All you need to do is loosen the adjustment screw and watch your speakers or spotlights rise - up to a height of 194 cm.

The stand ensures maximum stability with support feet made of die-cast aluminium and a height-adjustable steel sleeve that is virtually indestructible - as with all Gravity® stands.

The ergonomic adjustment screws on the top of the sleeve and bottom of the base are made of highly resistant ABS with a non-slip soft-touch cover made of thermoplastic. They provide for very comfortable handling when screwing open and closed. A set of black rings is also included in the scope of delivery and additional colours are available for personalization.

The Gravity® SP 5211 GS B speaker stand offers you heavy-duty and back-friendly support, which will be a loyal companion for many gigs to come - thanks to its sturdy construction.

Item Number:	GSP5211GSB
Product type	Stands and tripods
Type	Speaker stand
Tubing material	Aluminum
Colour	Black
Surface	Powder coated
Min. height	1150 mm
Max. height	1940 mm
Transport length	1110 mm
Height adjustment	Clamp, gas spring
Material of height adjustment	Steel
Base type	Leg joint
Base material	Die-cast aluminium
Tubing diameter	35 mm
Lifting force	18 kg
Max. load	25 kg
Interchangeable rings	5 x 30 mm
Black ring pack included	Yes
Weight	4.5 kg

lifts automatically



# SPEAKER STANDS

## SP 5211 AC B

STEEL SPEAKER STAND PNEUMATIC 35 MM BLACK

The SP 5211 AC B is a classic tripod speaker stand made from thick walled, yet lightweight powder coated aluminum tubing with a load capacity of 50 kg and 195 cm maximum height. The die-cast aluminum leg collar has been completely redesigned to provide superior durability and longevity, the height adjustment collar is made of steel for additional strength and is virtually indestructible. It features a safety pin to securely lock the 35 mm diameter extension pole in place. The ergonomic set screw knobs are made from high grade ABS with a soft touch, non-slip thermoplastic coating for comfortable operation. The built in air cushion acts as a pneumatic shock absorber and allows you to gently lower even heavy loads. A set of black coding rings is included with the SP 5211 AC B, additional ring packs are available in a wide array of colours for instant personalization.

Product number	GSP5211ACB
Product type	Stands and tripods
Type	Speaker stands
Tubing material	Aluminum
Colour	Black
Surface	Powder coated
Min height:	1060 mm
Max height	1950 mm
Transport length	1050 mm
Height adjustment	Yes
Material of height adjustment	Steel
Base type	Tripod
Base material	Die-cast aluminum
Tubing diameter	35 mm
Max. load	50 kg
Black ring pack included	Yes
Weight	2.8 kg



## SP 4722 B

### WIND-UP SPEAKER STAND

The Gravity® SP 4722 B is a heavy-duty speaker stand with a convenient hand crank and rack and pinion that make it easy to raise your speakers to the desired height. It is made of hard-wearing steel tubing with a folding tripod base and durable cast aluminum leg collar. A large knob set screw and safety pin secure the telescoping pole, which extends from 1.5 m to a maximum height of 2.4 m. The stand is TÜV/GS certified.

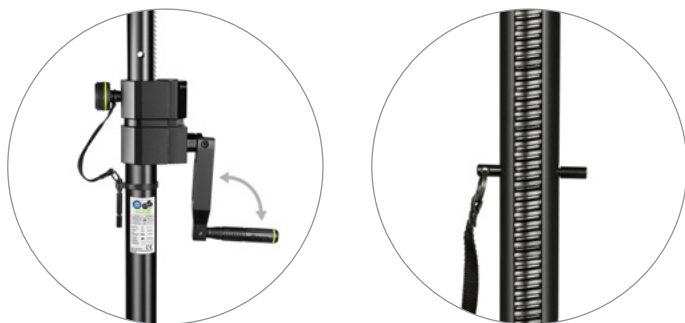

Product number	GSP4722B
Product type	Stands and tripods
Type	Speaker stands
Tubing material	Steel
Colour	Black
Surface	Powder coated
Min height:	1500 mm
Transport length	1480 mm
Max height	2400 mm
Joint material	Metal
Tubing diameter	35 mm
Max. load	40 kg
Interchangeable rings	4 x 30 mm, 1 x 25 mm, 1 x 15 mm
Black ring pack included	Yes
Weight	9.31 kg
Additional information	TÜV/GS certified



# SPEAKER STANDS

## SSP WB SET 1 / W

### SPEAKER STAND WITH ROUND CAST IRON BASE

Sporting a smaller footprint than conventional tripods this heavy-duty speaker stand features a 35 mm steel pole with unbreakable steel collar, ergonomic set screw knob and safety pin for easy and secure height adjustment. It extends from 1.05 to 1.8 m in 7.5 cm increments. The heavy, low-profile 10 kg cast iron base with additional 5 kg weight plate provides a secure footing and increased stability.

<b>Product number</b>	<b>GSSPWSET1 / W</b>
Product type	Stands and tripods
Type	Lighting stands, speaker stands
Max. load capacity	25 kg
Weight	17.1 kg
<b>Gravity® round cast iron base for M20 poles</b>	<b>GWB123B / W</b>
Product type	Stands and tripod accessories
Type	Round base plate
Material	Die-cast iron
Surface	Powder coated
Diameter	450 mm
Colour	Black / white
Threaded connector	M20 female
Additional information	5 kg extra weight plate available
Weight	9.7 kg
<b>Extra weight plate for round base</b>	<b>GWB123WPB</b>
Product type	Stands and tripod accessories
Material	Cast iron
Colour	Black
Surface	Powder coated
Diameter	350 mm
Features	Weight plate can be mounted quickly and without tools
Weight	5 kg
<b>Gravity® adjustable speaker pole 35 mm</b>	<b>GSP2342B / W</b>
Product type	Stands and tripod accessories
Tubing material	Steel
Colour	Black / white
Surface	Powder coated
Tubing diameter	35 mm
Threaded connector	M20
Min. / max. height	1050 mm / 1800 mm
Transport length	1050 mm
Height adjustment	Set screw with safety pin
Interchangeable rings	1 x 30 mm
Black ring pack included	Yes
Weight	2.1 kg





## SP 3202 CS B

### STUDIO MONITOR SPEAKER STAND WITH SQUARE STEEL BASE

The Gravity SP 3202 CS B studio monitor stand features a square steel base plate that – weighing in at almost 7 kg – ensures that the product stands securely and perfectly stable at all times. The base plate also has a rubberised handle for easy transport, and is equipped with a total of three M20 threads: one in the centre of the plate, and two at the edge. This provides more flexibility when setting it up.

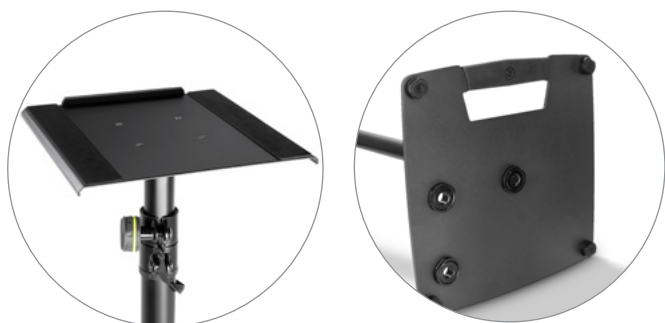

Product number	GSP3202CSB
Product type	Stands and tripods
Type	Speaker stands
Tubing material	Steel
Colour	Black
Surface	Powder coated
Min. height:	860 mm
Max. height	1500 mm
Height adjustment	Adjusting screw
Bearing surface	250 x 250 mm, EVA padded
Base type	Square
Base material	Steel
Base dimensions	390 x 25 x 390 mm
Lower connector	M20
Base weight	6.74 kg
Tubing diameter	42 mm / 35 mm
Centric load capacity	40 kg
Uncentric loading	20 kg
Interchangeable rings	1 x 25 mm, 1 x 30 mm
Black ring pack included	Yes
Weight	10.2 kg



# SPEAKER STANDS

## SP 3202 LR B

### STUDIO MONITOR SPEAKER STAND WITH LARGE ROUND BASE

The Gravity SP 3202 LR B studio monitor stand has a round cast iron base plate that weighs 9 kg for a secure stand and can be increased by a further 5 kg with the optional WB 123 WP B weight plate if required. For optimum speaker positioning, the stand can be easily adjusted in height from 860 mm to 1500 mm and fixed in place with an adjusting screw and a locking pin. The speaker support measures 250 mm x 250 mm and is equipped with EVA to protect and decouple the studio monitors for best sound performance.



Product number	GSP3202LRB
Product type	Stands and tripods
Type	Speaker stands
Tubing material	Steel
Colour	Black
Surface	Powder coated
Min. height:	860 mm
Max. height	1500 mm
Height adjustment	Adjusting screw
Bearing surface	250 x 250 mm, EVA padded
Base type	Round base
Base material	Cast iron
Base diameter	450 mm
Lower connector	M20
Base weight	9 kg
Tubing diameter	42 mm / 35 mm
Max. load capacity	40 kg
Interchangeable rings	1 x 25 mm, 1 x 30 mm
Black ring pack included	Yes
Weight	12 kg



## SP 3202 / VT

### STUDIO MONITOR SPEAKER STAND

The Gravity® SP 3202 / VT monitor speaker stands features a heavy triangular cast iron base and 25 x 25 cm steel tray with isolating foam rests and (SP 3202 VT) variable tilt up to 10°. It is height-adjustable from 90 to 150 cm for optimum speaker positioning and comes with a set of spikes that mount to the large integrated rubber feet for superior acoustic decoupling to the floor.



Product number	GSP3202VT	GSP3202
Product type	Stands and tripods	Stands and tripods
Type	Speaker stands	Speaker stands
Tubing material	Steel	Steel
Colour	Black	Black
Surface	Powder coated	Powder coated
Min height:	930 mm	900 mm
Max height	1530 mm	1500 mm
Height adjustment	Clamp with safety pin	Clamp with safety pin
Base type	3-point	3-point
Base material	Cast iron	Cast iron
Base edge length	292.5 mm	292.5 mm
Lower connector	M20	M20
Tubing diameter	42 mm/35 mm	42 mm/35 mm
Max. load (without spikes)	50 kg	50 kg
Max. load (with spikes)	30 kg	30 kg
Interchangeable rings	1 x 15 mm, 1 x 20 mm, 1 x 30 mm	1 x 25 mm, 1 x 30 mm
Black ring pack included	Yes	Yes
Weight	7 kg	6.5 kg
Additional information	Including acoustic isolation spikes	Including acoustic isolation spikes

# SPEAKER STANDS

## TOURING SERIES

### TSP 2332 B

ADJUSTABLE TOURING SPEAKER POLE 35 MM TO M 20  
1400 MM

To make sure that you can mount your speakers on your subwoofers in a time-saving and optimal way during tough touring conditions, Gravity® offers the TSP 2332 B speaker pole.

The solid construction made of black powder-coated steel is height adjustable from 82 to 140 cm using the automatic LockPin® mechanism specially designed for the Touring series.

This makes setup much faster, because the height adjustment lock snaps automatically into place when pulled up. No additional pin is required.

The Gravity® TSP 2332 B has an M20 thread at the bottom end of the pole, so you can simply screw it onto your subwoofer.

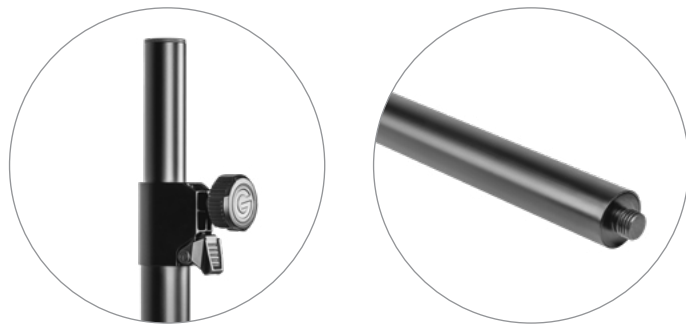

Product number	GTSP2332B
Product type	Stands and tripods
Type	Speaker stands
Tubing material	Steel
Colour	Black
Surface	Powder coated
Min. height	820 mm
Max. height	1400 mm
Transport length	820 mm
Height adjustment	Automatic LockPin®
Connector 1	M 20
Connector 2	35 mm
Max load	40 kg
Weight	2.78 kg



Get your tough stuff at  
[gravitystands.com/TOURINGSERIES](https://gravitystands.com/TOURINGSERIES)

## SP 2342 GS B

ADJUSTABLE GAS SPRING SPEAKER POLE 35 MM TO M20  
1790 MM

Raising and lowering your loudspeakers while being kind to your back - that's what the Gravity® SP 2342 GS B speaker pole with gas spring was made for.

The SP 2342 GS B is a classic speaker pole made of strong, lightweight aluminum. A gas spring is installed inside the pole, which lifts all conventional loudspeakers weighing up to 18 kg. All you need to do is loosen the adjustment screw - and watch your speakers go up.

The pole ensures maximum stability, as the steel sleeve of the height adjustment is practically indestructible - as with all Gravity® stands and poles. Fully extended, the speaker pole is 110.5 cm long and the M20 thread at the lower end allows you to screw it onto all standard PA subwoofers and stands.

The ergonomic adjustment screw on the sleeve is made of highly resistant ABS with a non-slip soft-touch thermoplastic cover, making it comfortable to screw on and off. A set of black rings is also included in the scope of delivery and additional colours are available for personalization.

The Gravity® SP 2342 GS B speaker pole offers you heavy-duty and back-friendly support, which will be a loyal companion for many gigs to come - thanks to its sturdy construction.



Product number	GSP2342GSB
Product type	Stands and tripods
Type	Distance bar
Tubing material	Steel
Colour	Black
Surface	Powder coated
Tube diameter	35 mm
Threaded connector	M20
Min. height	1145 mm
Max. height	1790 mm
Transport length	1105 mm
Height adjustment	Adjusting screw, gas spring
Lifting force	18 kg
Max load	25 kg
Interchangeable rings	1 x 30 mm
Black ring pack included	Yes
Weight	3.2 kg



# SPEAKER STANDS



## SP 2342 B / W

ADJUSTABLE SPEAKER POLE FOR 35 MM TO M20  
1800 MM

Product number	GSP2342B / W
Product type	Stands and tripod accessories
Type	Distance bar
Colour	Black / white
Surface	Powder coated
Tube diameter	35 mm
Threaded connector	M20
Min height:	1050 mm
Max height	1800 mm
Interchangeable rings	1 x 30 mm
Black ring pack included	Yes
Weight	2.1 kg



## SP 2332 EXT B / W

SPEAKER POLE EXTENSION

Product number	GSP2332EXTB / W
Product type	Stands and tripod accessories
Material	Steel
Colour	Black / white
Surface	Powder coated
Length	500 mm
Threaded connector	M20 male
Threaded connector 2	M20 female
Weight	0.9 kg



## SP 2472 B

### ADJUSTABLE SPEAKER POLE WITH CRANK 35 MM TO M20

The Gravity® SP 2472 B is a rugged 35 mm extension rod with practical winding gear for easy raising and lowering of the speaker. It is made of heavy-duty, black powder coated steel, has a 40 kg load capacity and is height-adjustable from 1.02 m to 1.64 m. The stand is TÜV/GS certified.

Product number	GSP2472B
Product type	Stands and tripod accessories
Type	Distance bar
Tubing material	Steel
Colour	Black
Surface	Powder coated
Min height:	1025 mm
Max height	1645 mm
Joint material	Metal
Tubing diameter	35 mm
Max. load	40 kg
Interchangeable rings	1 x 15 mm, 1 x 30 mm
Black ring pack included	Yes
Weight	3.3 kg
Additional information	TÜV-certified



# SPEAKER STANDS



## SP 2332 B

ADJUSTABLE SPEAKER POLE 35 MM TO M20  
1400 MM

Product number	GSP2332B
Product type	Stands and tripods
Type	Speaker stands
Tubing material	Steel
Colour	Black
Surface	Powder coated
Min height:	820 mm
Max height	1400 mm
Transport length	820 mm
Height adjustment	Clamp with safety pin
Material of height adjustment	Steel
Connector 1	M20
Connector 2	35 mm
Max. load	40 kg
Interchangeable rings	1 x 30 mm
Black ring pack included	Yes
Weight	1.84 kg



## SP 3332 B

ADJUSTABLE SPEAKER POLE 35 MM TO 35 MM  
1400 MM

Product number	GSP3332B
Product type	Stands and tripods
Type	Speaker stands
Tubing material	Steel
Colour	Black
Surface	Powder coated
Min height:	820 mm
Max height	1400 mm
Transport length	820 mm
Height adjustment	Clamp with safety pin
Material of height adjustment	Steel
Connector 1	35 mm
Connector 2	35 mm
Max. load	40 kg
Interchangeable rings	1 x 30 mm
Black ring pack included	Yes
Weight	1.56 kg



## SP 2332 TPB

ADJUSTABLE TWO PART SPEAKER POLE 35 MM TO M20  
1400 MM

Product number	GSP2332TPB
Product type	Stands and tripods
Type	Speaker stands
Tubing material	Steel
Colour	Black
Surface	Powder coated
Min height:	1050 mm
Max height	1400 mm
Transport length	540 mm
Height adjustment	Clamp with safety pin
Material of height adjustment	Steel
Connector 1	M20
Connector 2	35 mm
Max. load	40 kg
Interchangeable rings	1 x 30 mm
Black ring pack included	Yes
Weight	2.2 kg



## SP 3332 TPB

ADJUSTABLE TWO PART SPEAKER POLE 35 MM TO 35 MM  
1400 MM

Product number	GSP3332TPB
Product type	Stands and tripods
Type	Speaker stands
Tubing material	Steel
Colour	Black
Surface	Powder coated
Min height:	1050 mm
Max height	1400 mm
Transport length	540 mm
Height adjustment	Clamp with safety pin
Material of height adjustment	Steel
Connector 1	35 mm
Connector 2	35 mm
Max. load	40 kg
Interchangeable rings	1 x 30 mm
Black ring pack included	Yes
Weight	2.15 kg

# SPEAKER STANDS



## SP 3102 TM

### FLEXIBLE STUDIO MONITOR STAND WITH TABLE CLAMP

A mix's sound and feel is heavily influenced by having your monitors placed in the proper position. In a home studio, however, where space is at a premium, it's not always possible to put your studio monitors right next to a table using suitable stands. The Gravity® SP 3102 & SP 3102 TM are the perfect solution to this problem.

Product number	GSP3102TM
Product type	Stands and tripods
Type	Speaker stands
Tubing material	Steel
Colour	Black
Surface	Powder coated
Min. height	250 mm
Max. height	350 mm
Tilt angle	+/- 15°
Rotation	360°
Bearing surface	250 x 250 mm, EVA padded
Height adjustment	Adjusting screw
Clamp base material	Steel
Clamp base edge length	100 x 70 mm
Clamping range up to	100 mm
Max. load	25 kg
Interchangeable rings	2 x 30 mm 1 x 15 mm
Black ring pack included	Yes
Weight	2.7 kg



## SP 3102

### STUDIO MONITOR SPEAKER STAND

The flexible, powder coated steel stand squeezes onto pretty much any desk. The edge of the solid base is only 25 cm in length. Monitor speakers weighting up to 25 kg can be flexibly positioned at the height you want. EVA padding and a tilting option make it possible to vertically angle them by up to 15° and horizontally rotate them 360°, meaning you can always find the perfect position for your studio monitors.

Product number	GSP3102
Product type	Stands and tripods
Type	Speaker stands
Tubing material	Steel
Colour	Black
Surface	Powder coated
Min height:	263 mm
Max height	358 mm
Tilt angle:	+/- 15°
Bearing surface	250 x 250 mm, EVA padded
Height adjustment	Adjusting screw
Base material	Steel
Base edge length	250 mm
Max. load	25 kg
Interchangeable rings	1 x 20 mm, 1 x 30 mm
Black ring pack included	Yes
Weight	4.1 kg



## SP 3102 C B

### COMPACT STUDIO MONITOR TABLE STAND

Professional productions need a big studio - this guiding principle was considered irrefutable for decades. Today, entire albums are produced in small home studios. Getting the most out of a cramped environment requires compact and well thought-out solutions, like the Gravity® SP 3102 C B studio monitor table stand.

With the SP 3102 C B, you can place your studio monitors directly on your desk without worrying about stability or taking up too much space. Thanks to the continuously height adjustment, the monitoring speakers can be precisely aligned with your sitting position - and the stereo triangle is ready!

The SP 3102 C B is based on a robust steel construction that ensures a secure stand for your studio monitors. The rubberised non-slip feet on the bottom of the table base and the EVA-padded bearing surface for the speaker also contribute to this.

The Gravity® SP 3102 C B is the ideal solution for small tables in home studios and is aimed at users who do not want to give up on a stable stand and precise alignment of the monitors even in cramped environments.



Product number	GSP3102CB
Product type	Stands and tripods
Type	Speaker stands
Material	Steel
Colour	Black
Surface	Powder coated
Min height:	150 mm
Max height	250 mm
Bearing surface	160 x 180 mm, EVA padded
Height adjustment	Adjusting screw
Base edge dimensions	220 x 205 mm
Max. load	15 kg
Interchangeable rings	1 x 30 mm
Black ring pack included	Yes
Weight	4.4 kg

# SPEAKER STANDS



## SP WMBS 20 B / W

TILT AND SWIVEL WALL MOUNT FOR SPEAKERS UP TO 20 KG

Product number	GSPWMBS20B / W
Product type	Stands and tripods
Type	Speaker Stands
Material	Steel
Surface	Powder coated
Colour	Black / white
Max. load	20 kg
Weight	1.35 kg
Additional information	incl. universal mounting plate



160° swivel,  
0 to 40° down tilt,  
continuously variable



Easily readable tilt  
angle scale



6 mm wall plate with  
safety rope eyelet



## SP WMBS 30 B / W

TILT AND SWIVEL WALL MOUNT FOR SPEAKERS UP TO 30 KG

Product number	GSPWMBS30B / W
Product type	Stands and tripods
Type	Speaker stands
Material	Steel
Surface	Powder coated
Colour	Black / white
Max. load	30 kg
Weight	1.8 kg
Additional information	incl. universal mounting plate



160° swivel,  
0 to 40° down tilt,  
continuously variable



Easily readable tilt  
angle scale



6 mm wall plate with  
safety rope eyelet



## SAT 36 B

### ADJUSTABLE T-BAR FOR SPEAKER STANDS

The Gravity® T-Bar facilitates mounting two loudspeakers on a single stand. It is made of heavy-duty steel with a black powder coating finish and securely attaches to all 35 mm poles. Width is fully adjustable from 31 to 49 cm.

Product number	GSAT36B
Product type	Stands and tripods
Type	Speaker stands
Material	Steel
Colour	Black
Surface	Powder coated
Suitable for tube diameter	35 mm
Adjustable width	310 - 490 mm
Fitting	Screw clamp
Max. load	2 x 25 kg
Interchangeable rings	1 x 25 mm
Black ring pack included	Yes
Additional information	Assembly tool
Weight	1.4 kg



## SP WM 1 B

### TILTABLE AND SWIVELLING WALL MOUNT FOR STUDIO MONITORS

With this robust and stable wall mount, you can effortlessly position your monitors on the wall. Moreover, the SP WM 1 B provides all the necessary features for perfect monitor alignment to your listening position.

Product number	GSPWM1B
Product type	Stands and tripods
Type	Speaker stands
Material	Steel
Colour	Black
Surface	Powder coated
Pull-out	5-step (320 mm - 380 mm)
Pull-out angle	180°
Tilt angle	+/- 15°
Bearing angle	360°
Bearing surface	250 x 250 mm, EVA padded
Max. load	50 kg
Interchangeable rings	2 x 15 mm, 1 x 30 mm
Weight	3.1 kg



# ACCESSORIES SPEAKER STANDS

## SA BELT 1 B

### RETRACTABLE CROWD BARRIER CASSETTE FOR STAND MOUNTING

Whether you're an event technician, small event organiser or retailer, the SA BELT 1 B crowd barrier cassette for stand mounting offers you absolute flexibility for barriered zones, regulated visitor flow, and highlighting of walkways.

The Gravity® SA BELT 1 B crowd barrier cassette can be extended up to two meters and is self-tensioning. For the required hold of the belt, the retractable belt system has a useful locking function, whereby the belt is solidly held in place.

Any number of barrier cassettes can be combined with each other via the typical three strap clips.

With the SA BELT 1 B, there is no need to buy stands twice and fill up your storage space unnecessarily, as a 5/8" thread is integrated in the cassette itself, both at the top and bottom. Simply screw them onto any microphone or speaker stand with 3/8", 5/8" or M10 threads.

And to make sure you always have the right adapter at hand, the necessary adapters are included with this very cleverly conceived barrier belt system.

With the SA BELT 1 B, Gravity® offers you a versatile system to signalise short and long walkways, for entrance control, stage barriers or trade fairs.



Product number	GSABELT1B
Product type	Stands and tripod accessories
Type	Locking belt cassette
Cassette material	Plastic and steel
Colour	Black
Belt material	Nylon
Max belt length	1940 mm
Threaded connector	2 x 5/8" female
Accessories (included)	1 x adapter 5/8" male to M10; 1 x adapter 5/8" male to 3/8" male
Cassette dimensions (L x H x W)	100 x 133 x 80 mm
Weight	0.46 kg

## SA BELT 1 B SET 1

4 RETRACTABLE CROWD BARRIER CASSETTE FOR STAND MOUNTING INCL. BAG

Product number	GSABELT1BSET1
Product type	Stands and tripod accessories
Type	Locking belt cassette
Cassette material	Plastic and steel
Bag material	Nylon
Colour	Black
Belt material	Nylon
Max belt length	1940 mm
Threaded connector	2x 5/8" female
Accessories (included)	4x adapter 5/8" male to M10; 4x adapter 5/8" male to 3/8" male
Cassette dimensions (L x H x W)	100 x 133 x 80 mm
Weight per cassette	0.46 kg
Weight of bag	0.18 kg
Weight	2.02 kg



## SA BELT 1 B STAND SET 1

RETRACTABLE CROWD BARRIER CASSETTE STAND SET 1

Product number	GSABELT1BSTANDSET1	Product number	GMS23
Product type	Other stands and tripods	Product type	Stands and tripods
Type	Locking belt cassette system	Type	Microphone stands
Type weight	6.96 kg	Tubing material	Steel
		Colour	Black
		Surface	Powder coated
Product number	GSABELT1B	Min. height	1000 mm
Product type	Stands and tripod accessories	Max. height	1600 mm
Type	Locking belt cassette	Transport length	1000 mm
Cassette material	Plastic and steel	Height adjustment	Yes
Colour	Black	Base type	Round base
Belt material	Nylon	Base material	Cast iron
Max belt length	1940 mm	Base diameter	270 mm
Threaded connector	2 x 5/8" female	Base weight	3.6 kg
Accessories (included)	1 x adapter 5/8" male to M10; 1 x adapter 5/8" male to 3/8" male	Interchangeable rings	1 x 20 mm
Cassette dimensions (L x H x W)	100 x 133 x 80 mm	Black ring pack included	Yes
Weight	0.46 kg	Weight	4.2 kg
Product number	GMS2WP		
Product type	Stands and tripod accessories		
Colour	Black		
Surface	Powder coated		
Diameter	210 mm		
Weight	2.3 kg		





# ACCESSORIES SPEAKER STANDS



## SA BELT 1 B STAND SET 2 RETRACTABLE CROWD BARRIER CASSETTE STAND SET 2

<b>Product number</b>	<b>GSABELT1BSTANSET2</b>	<b>Product number</b>	<b>GSP1122B</b>
Product type	Other stands and tripods	Product type	Stands and tripods
Type	Locking belt cassette system	Type	Extension tube
Weight	11.51 kg	Material	Steel
		Colour	Black
<b>Product number</b>	<b>GSABELT1B</b>	Surface	Powder coated
Product type	Stands and tripod accessories	Weight	1.35 kg
Type	Locking belt cassette	Length	865 mm
Cassette material	Plastic and steel	Thr. connector 1	M20 male
Colour	Black	Threaded connector 2	M10 female
Belt material	Nylon		
Max belt length	1940 mm		
Threaded connector	2 x 5/8" female		
Accessories (included)	1 x adapter 5/8" male to M10; 1 x adapter 5/8" male to 3/8" male		
Cassette dimensions (L x H x W)	100 x 133 x 80 mm		
Weight	0.46 kg		
<b>Product number</b>	<b>GWB123B</b>		
Product type	Stands and tripod accessories		
Colour	Black		
Base material	Die-cast iron		
Diameter	450 mm		
Weight	9.71 kg		



## SA VESA 1

### 35 MM POLE MOUNT LCD TV MONITOR BRACKET

This universal bracket is suitable for all flat screen monitors with VESA standard mounting hole patterns from 75 x 75 to 400 x 400 mm and securely clamps to 35 mm speaker poles. The heavy duty steel construction with black powder coating finish has a maximum load capacity of 30 kg and comes complete with sets of M8 and M6 monitor mounting screws.

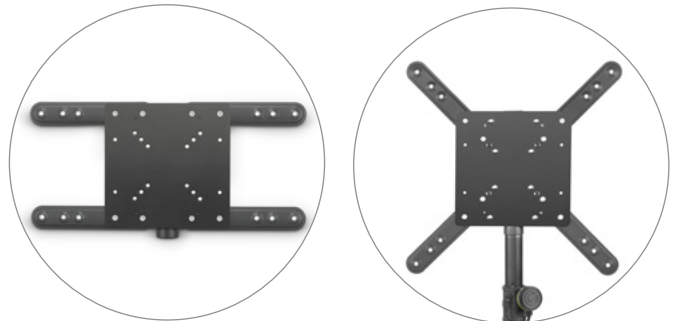

Product number	GSAVESAT1
Product type	Stands and tripods accessories
Type	Universal monitor mount
Material	Steel
Surface	Powder coated
Colour	Black
Suitable for tube diameter	35 mm
Max. load	30 kg
Suitable for VESA dimensions	75 x 75, 100 x 100, 200 x 100, 200 x 200, 300 x 300, 400 x 200, 400 x 400
Dimensions base plate	240 x 240 mm
Material thickness base plate	3 mm
Length extensions	240 mm
Width extensions	45 mm
Material thickness extensions	2 mm
Interchangeable rings	1 x 25 mm
Black ring pack included	Yes
Accessories (included)	4 x extensions, 4 x M6 screws, 4x distance holders, Base plate with 35 mm pole mount and locking screw, 4 x M8 screws, 8 x M6 countersunk screws
Weight	2.71 kg



## SP VARI®-LEG 01

LEVELING LEG FOR LOUDSPEAKER AND LIGHTING STANDS

Place your speaker or lighting stands securely on uneven or slanted subfloors including steps and stairs. Gravity's VARI®-LEG 01 leveling leg provides continuously variable leg length compensation up to 25 cm. It fits all leg tubes with 33 to 37 mm inner diameter, mounts quickly and easily without the need for tools and remains on the stand when no leveling is required.



## SA LC 35 B

CLIP-ON SPIRIT LEVEL FOR 35 MM POLES

Mounting Gravity® VARI®-POLES and similar products perfectly horizontal or vertical is dead easy with this spirit level. Made of heavy-duty ABS, it simply clips to any pole with 34 to 45 mm diameter. In addition, the Gravity® clip-on spirit level is a must-have accessory for loudspeaker stands with levelling legs, e.g. the Gravity® VARI®-LEG.



Product number	GSPVARILEG01
Product type	Stands and tripods
Type	Extension
Material	Steel / plastic
Surface	Powder coated
Colour	Black
Suitable for inner tube diameter	33 - 37 mm
Length	340 mm
Max. Extension	250 mm
Accessories (included)	2 x Compensating Feet, clip for the spirit level
Weight	0.33 kg

Product number	GSALC35B
Product type	Stands and tripod accessories
Material	ABS plastic
Colour	Black
Suitable for tube diameter	34 - 45 mm
Weight	0.01 kg

# ACCESSORIES SPEAKER STANDS



## WB 123 SET 1 B

ROUND CAST IRON BASE AND WEIGHT PLATE SET FOR M20 POLES

The set includes a flat, cast-iron 10 kg round base and a weight disc from our patented VARI®-WEIGHT stability system, ensuring both a more secure footing and more convenient transport of the system as a whole. The disc weighs 5 kg and can be quickly assembled without tools. It is suitable for extension tubes with an M20 screw thread and provides for a particularly sturdy stand.

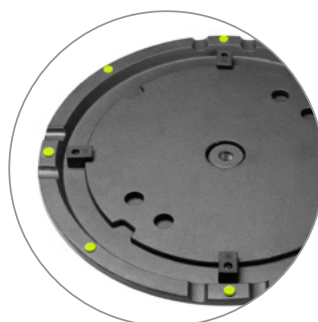
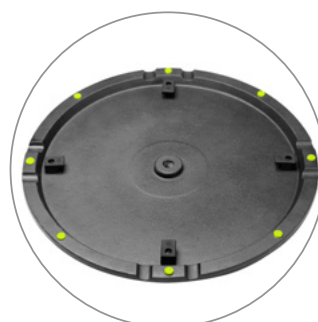

<b>Product number</b>	<b>GWB123SET1B</b>
Product type	Stands and tripod accessories
Weight	14.71 kg
<b>Gravity® round cast iron base for M20 poles</b>	<b>GWB123B</b>
Product type	Stands and tripod accessories
Type	Round base plate
Material	Die-cast iron
Colour	Black
Surface	Powder coated
Diameter	450 mm
Threaded connector	M20 female
Additional information	5 kg extra weight plate available
Weight	9.71 kg
<b>Extra weight plate for round base</b>	<b>GWB123WPB</b>
Material	Cast iron
Colour	Black
Surface	Powder coated
Diameter	350 mm
Features	Weight plate can be mounted quickly and without tools.
Weight	5 kg



## WB 123 B / W

### ROUND CAST IRON BASE FOR M20 POLES

This flat, heavy round base made of cast iron accepts extension tubes with an M20 screw thread and ensures a secure footing with a weight of 9 kg. For increased stability, a 5 kg weight disc is available as an accessory (item no. WB 123 WPB), which is easily assembled without tools.

VARI®-WEIGHT – patented stability system for secure holding and simple transportation by means of an insertable weight disc.



Product number	GWB123B / W
Product type	Stands and tripod accessories
Type	Base
Material	Die-cast iron
Surface	Powder coated
Colour	Black / white
Diameter	450 mm
Threaded connector	M20 female
Additional information	5 kg extra weight plate available
Weight	9.71 kg

# ACCESSORIES SPEAKER STANDS



**SA VARI®-TILT**  
VARIABLE SPEAKER TILT ADAPTER

Product number	GSAVARITILT
Product type	Stands and tripod accessories
Colour	Black
Material	Steel
Surface	Powder coated
Suitable for tube diameter	35 mm
Tilt angle	0 - 15 °
Length	190 mm
Max. load	30 kg
Interchangeable rings	1 x 25 mm
Black ring pack included	Yes
Weight	0.6 kg



**SA FIXTILT 5**  
5° SPEAKER TILT ADAPTER

Product number	GSAFIXTILT5
Product type	Stands and tripod accessories
Colour	Black
Material	Steel
Surface	Powder coated
Suitable for tube diameter	35 mm
Tilt angle	5 °
Length	190 mm
Max. load	30 kg
Interchangeable rings	1 x 25 mm
Black ring pack included	Yes
Weight	0.5 kg



**SA GRIP LOCK**  
GRIP LOCK ADAPTER SLEEVE  
FOR SPEAKER STANDS

Product number	GSAGRIPLOCK
Product type	Stands and tripod accessories
Colour	Black
Material	Steel
Surface	Powder coated
Suitable for tube diameter	35 mm
Length	240 mm
Max. load	30 kg
Interchangeable rings	4 x 25 mm
Black ring pack included	Yes
Weight	0.55 kg



**SF 36 Z 38 M**  
REDUCER FLANGE FROM 36 MM  
TO 3/8" MALE

Product number	GSF36Z38M
Product type	Stands and tripod accessories
Colour	Black
Material	Steel
Surface	Powder coated
Suitable for tube diameter	35 mm
Threaded connector	3/8" x 12 mm
Type of adjustment	Screw clamp
Length	100 mm
Interchangeable rings	1 x 25 mm
Black ring pack included	Yes
Weight	0.49 kg



**SF 36 M 6 M**  
REDUCER FLANGE FROM 36 MM  
TO M6 MALE

Product number	GSF36M6M
Product type	Stands and tripod accessories
Colour	Black
Material	Steel
Surface	Powder coated
Suitable for tube diameter	35 mm
Threaded connector	M6 x 12 mm
Type of adjustment	Screw clamp
Length	100 mm
Interchangeable rings	1 x 25 mm
Black ring pack included	Yes
Weight	0.49 kg



**SF 36 M 10 M**  
REDUCER FLANGE FROM 36 MM  
TO M10 MALE

Product number	GSF36M10M
Product type	Stands and tripod accessories
Colour	Black
Material	Steel
Surface	Powder coated
Suitable for tube diameter	35 mm
Threaded connector	M10
Type of adjustment	Screw clamp
Length	100 mm
Interchangeable rings	1 x 25 mm
Black ring pack included	Yes
Weight	0.49 kg





### SF 36 T 28 F L

LONG REDUCING FLANGE  
36 MM TO TV28 FEMALE

Product number	GSF36T28FL
Product type	Stands and tripod accessories
Colour	Black
Surface	Powder coated
Suitable for tube diameter	35 mm
Threaded connector	28 mm (TV28)
Type of adjustment	Screw clamp
Length	195 mm
Interchangeable rings	1 x 25 mm
Black ring pack included	Yes
Weight	1.25 kg



### SF CURV M

REDUCING FLANGE 36 MM TO  
CURV FLANGE MALE

Product number	GSFCURVM
Product type	Stands and tripod accessories
Colour	Black
Material	Steel
Surface	Powder coated
Suitable for tube diameter	35 mm
Reduced to	Curv - Flange 16 mm
Type of adjustment	Screw clamp
Length	165 mm
Interchangeable rings	1 x 25 mm
Black ring pack included	Yes
Weight	0.3 kg



### SF 36 M 10 F

REDUCER FLANGE FROM 36 MM  
TO M10 FEMALE

Product number	GSF36M10F
Product type	Stands and tripod accessories
Colour	Black
Material	Steel
Surface	Powder coated
Suitable for tube diameter	35 mm
Threaded connector	M10 Thread
Type of adjustment	Screw clamp
Length	100 mm
Interchangeable rings	1 x 25 mm
Black ring pack included	Yes
Weight	0.47 kg
Accessories (included)	Bolt M10 x 25 / washer



### SF 36 T 28 F

REDUCER FLANGE FROM 36 MM  
TO TV28 FEMALE

Product number	GSF36T28F
Product type	Stands and tripod accessories
Colour	Black
Material	Steel
Surface	Powder coated
Suitable for tube diameter	35 mm
Threaded connector	28 mm (TV28)
Type of adjustment	Screw clamp
Length	100 mm
Interchangeable rings	1 x 25 mm
Black ring pack included	Yes
Weight	0.72 kg



### SF 36 16 M

REDUCER FLANGE FROM 36 MM  
TO 16 MM MALE

Product number	GSF3616M
Product type	Stands and tripod accessories
Colour	Black
Material	Steel
Surface	Powder coated
Suitable for tube diameter	35 mm
Reduced to	16 mm
Type of adjustment	Screw clamp
Length	140 mm
Interchangeable rings	1 x 25 mm
Black ring pack included	Yes
Weight	0.53 kg



### SF 20 M 20

SPACER FROM 41 MM  
TO 35 MM M20

Product number	GSF20M20
Product type	Stands and tripod accessories
Colour	Black
Material	Steel
Surface	Powder coated
Length (with thread)	135 mm (150 mm)
Diameter	41 mm to 35 mm
Threaded connector 1	M20 male
Threaded connector 2	M20 female
Weight	0.45 kg

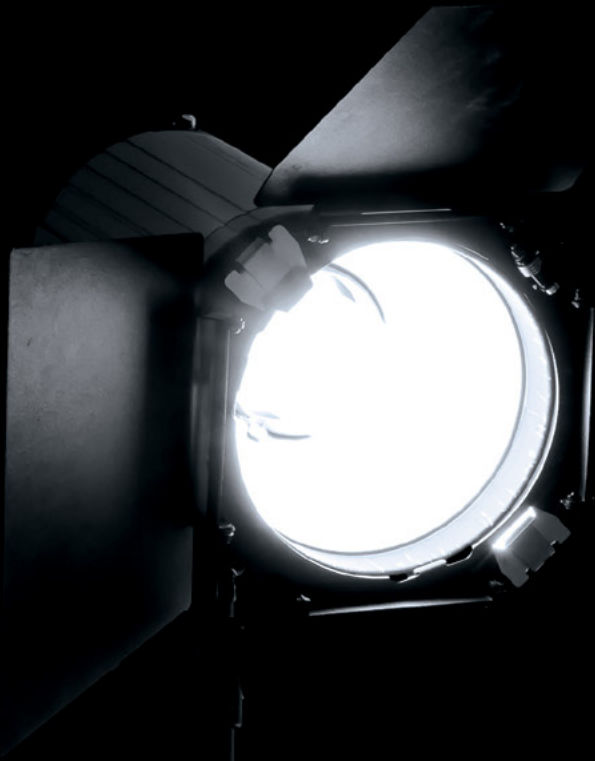

# LIGHTING STANDS

Featuring premium materials and ultra durable construction, Gravity® lighting stands ensure years of reliable service. They are available in classic tripod versions or with a heavy low-profile steel base for unobtrusive placement. Gravity® lighting stands provide secure adjustment and maximum stability to safely put your fixtures where you need them.

# LIGHTING STANDS

## TOURING SERIES

### TLS 431 B

#### TOURING-LIGHTING STAND WITH SQUARE STEEL BASE

Well equipped to handle the daily grind and time constraints of touring: That's the TLS 431 B light stand from the Gravity® Touring Series. Its heavy steel base featuring three M20 female threads for off-centre installation guarantees a firm footing in all circumstances, whereas two integrated handles make it easy to transport. In comparison to the standard series, the base is slightly smaller, but it still offers the same amount of stability. The added bonus here is that it can now also be used as a divider in Transflex cases. The base-to-pole connection has been made stronger by adding a reinforcing sleeve to prevent wobbling. With the 35 mm extension tube featuring a M10 female thread, the stand can be extended in height up to 2.40 meters. Thanks to the automatic LockPin® technology, it has never been easier to adjust the height of a stand. Because the pin automatically snaps into the holes when adjusting upwards, a separate locking pin is no longer necessary.



Product number	GTLS431B
Product type	Stands and tripods
Type	Lighting stands
Tubing material	Steel
Colour	Black
Surface	Powder coated
Min. height	1430 mm
Max. height	2420 mm
Transport length	1430 mm
Height adjustment	Automatic LockPin®
Base material	Steel
Material of height adjustment	Steel
Tube diameter	35 mm
Dimensions Base (W x H x D)	537 x 20 x 535 mm
Base weight	12.35 kg
Max. load capacity	25 kg
Weight	17 kg

## TWB 431 B

SQUARE STEEL TOURING BASE WITH EXCENTRIC MOUNTING OPTION

Product number	GTWB431B
Product type	Stands and tripod accessories
Type	Square steel base
Colour	Black
Material	Steel
Surface	Powder coated
Dimensions (W x H x D)	537 x 20 x 535 mm
Max. load	25 kg
Weight	12.35 kg

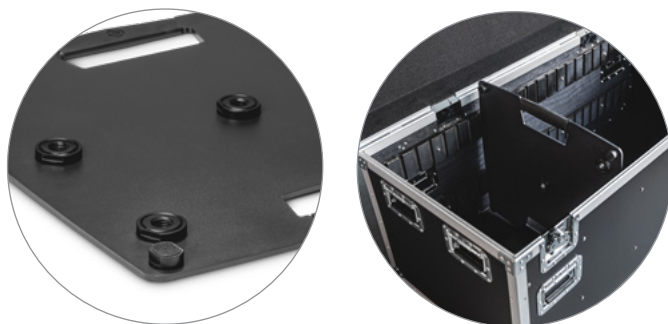

## TLS P 431

TOURING DISTANCE POLE FOR GTLS431B / GLS431B / GLS331B

Product number	GTLSP431
Product type	Stands and tripods
Type	Lighting stands
Tubing material	Steel
Colour	Black
Surface	Powder coated
Min. height	1430 mm
Max. height	2400 mm
Transport length	1430 mm
Height adjustment	Automatic LockPin®
Material of height adjustment	Steel
Max. load capacity	25 kg
Weight	4.65 kg

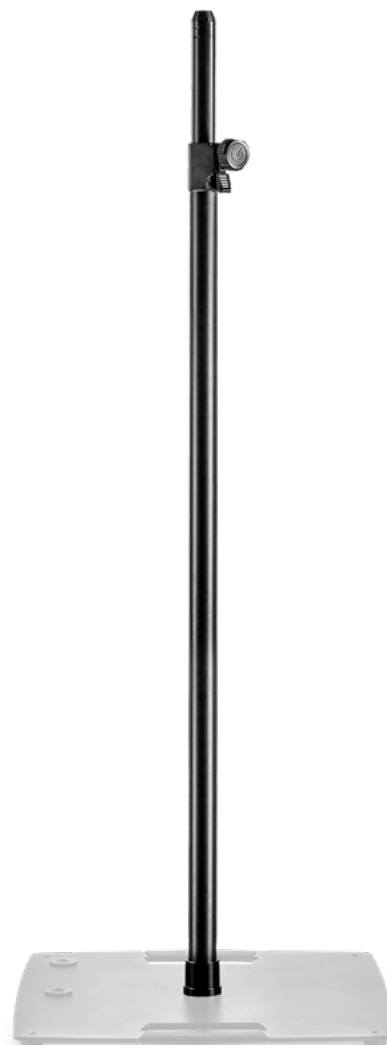



# LIGHTING STANDS

## LS 431 C B

### LIGHTING AND SPEAKER STAND WITH COMPACT SQUARE STEEL BASE AND EXCENTRIC MOUNTING OPTION

The Gravity® lighting- and speaker stand LS 431 C B features a compact heavy steel base which provides a firm footing and three M20 female threads that allow to mount your lights and loudspeakers off-centre. The 35 mm extension gives you a maximum height of 1.84 m. The integrated base handle facilitates transport and the felt-covered feet protects any surface from scratches.

Product number	GLS431CB
Product type	Stands and tripods
Type	Lighting stands
Tubing material	Steel
Colour	Black
Surface	Powder coated
Min. height	1050 mm
Max. height	1840 mm
Transport length	1050 mm
Number of extensions	1
Base material	Steel
Base Dimensions	390 x 25 x 390 mm
Base weight	6.74 kg
Interchangable rings	1 x 30 mm
Black ring pack included	Yes
Max. load capacity	30 kg
Weight	8.84 kg



## WB 431 C B

### COMPACT SQUARE STEEL BASE WITH EXCENTRIC MOUNTING OPTION

Product number	GWB431CB
Product type	Stands and tripod accessories
Type	Base
Material	Steel
Colour	Black
Surface	Powder coated
Dimensions	390 x 25 x 390 mm
Threaded connector	M20 female
Weight	6.74 kg



## LS 331 B

### LIGHTING AND SPEAKER STAND WITH SQUARE STEEL BASE

The LS 331 B lighting stand features a large heavy steel base providing a firm footing and a single extension for a maximum height of 2.4 m. The 35 mm pole includes a female threaded M10 insert, the base tube has a male M20 end. Two integrated base handles facilitate transport.

## LS 431 B / W

### LIGHTING AND SPEAKER STAND WITH SQUARE STEEL BASE AND EXCENTRIC MOUNTING OPTION

The LS 431 B / W lighting stand features a large heavy steel base providing a firm footing and three M20 female threads that allow to mount the pole off-centre. The 35 mm pole extension is equipped with a pressed in female M10 thread to be able to mount lighting gear on top. The maximum height is at 2.4 m and the integrated base handles facilitate transport.

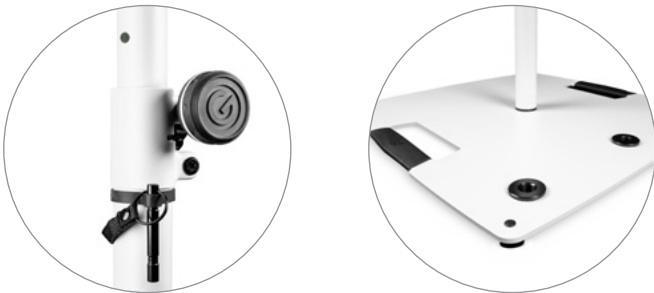

Product number	GLS331B	GLS431B / W
Product type	Stands and tripods	Stands and tripods
Type	Lighting stands	Lighting stands
Tubing material	Steel	Steel
Colour	Black	White
Surface	Powder coated	Powder coated
Min height:	1420 mm	1420 mm
Max height	2420 mm	2420 mm
Transport length	1420 mm	1420 mm
Height adjustment	Set screw and safety pin	Set screw and safety pin
Number of extensions	1	1
Base material	Steel	Steel
Material of height adjustment	Steel	Steel
Tube diameter	35 mm	35 mm
Dimensions Base (W x H x D)	563 x 15 x 563 mm	563 x 15 x 563 mm
Base weight	13.8 kg	13.8 kg
Interchangeable rings	1 x 30 mm	1 x 30 mm
Black ring pack included	Yes	Yes
Max. load capacity	20 kg	20 kg
Weight	17.8 kg	17.8 kg



**LS M20 KEY  
M20 Wrench  
individually  
available**

# LIGHTING STANDS

## LS VARI®-POLE 01 B

CLAMPING POLE WITH 210 - 370 CM LENGTH

Made of lightweight, black anodized aluminum tubing with a secure locking mechanism, the Gravity® VARI® POLE extends from 210 cm to 370 cm and quickly mounts between floors and ceilings. It is held in place by pressure, and strong rubber on both sides for a variety of other applications.

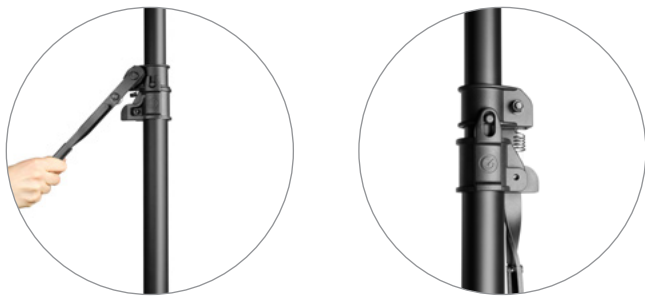

Product number	GLSVARIPOLE01B
Product type	Stands and tripods
Type	Clamping rod
Material	Aluminum
Colour	Black
Tubing surface	Anodized
Connection surface	Powder coated
Transport length	2100 mm
Clamping range	2100 - 3700 mm
Upper tube diameter	40 mm
Lower tube diameter	45 mm
Weight	2.2 kg



## LS TBTV 17 / 28

### LIGHTING STAND WITH T-BAR SMALL / LARGE

The LS TBTV 17 & LS TBTV 28 is a classic tripod lighting stand with twin extensions, made from thick walled, yet lightweight powder coated steel tubing. The die-cast aluminum leg collar has been completely redesigned to provide superior durability and longevity.

The unbreakable height adjustment collars are made of die-cast aluminum for additional strength. The ergonomic set screw knobs are made from high grade ABS with a soft touch, non-slip thermoplastic coating for comfortable handling. The stand includes a T-Bar with an ergonomically formed and rubberised T-Bar – making the T-Bar not only easier to handle and carry but also better looking than regular stands.

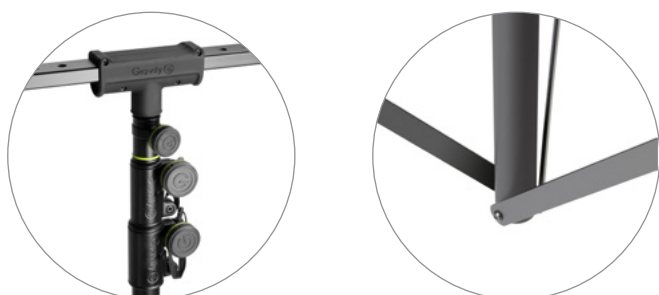

Product number	GLSTBTV17	GLSTBTV28
Product type	Stands and tripods	Stands and tripods
Type	Lighting stands	Lighting stands
Stand material	Steel	Steel
Truss material	Steel	Steel
Stand surface	Powder coated	Powder coated
Crossbar surface	Powder coated	Powder coated
Stand colour	Black	Black
Number of extensions	2	2
Min. height	1100 mm	1450 mm
Max. height	2500 mm	3250 mm
Transport length	1100 mm	1450 mm
Max. load	30 kg	50 kg
Holding fixture for TV spigot	Yes	Yes
TV spigot	17 mm	28 mm
Crossbar length	950 mm	1220 mm
Weight	5.7 kg	9.2 kg



# ACCESSORIES LIGHTING STANDS



## LS FLOORX B

FOLDABLE FLOOR STAND FOR SPOTS

The LS FLOORX B is a compact stand for placing light fixtures on the stage floor. The folding design of powder coated steel with ergonomic locking screw enables space saving storage, hefty rubber feet prevent marring of the floor while providing a secure grip.



Product number	GLSFLOORXB
Product type	Stands and tripods
Type	Lighting stands
Material	Steel
Colour	Black
Surface	Powder coated
Footprint	385 x 355 mm
Height	40 mm
Max. load capacity	14 kg
Black ring pack included	Yes
Weight	0.4 kg



## WB 431 B

SQUARE STEEL BASE WITH EXCENTRIC MOUNTING OPTION



Product number	GWB431B
Product type	Stands and tripod accessories
Type	Base
Material	Steel
Surface	Powder coated
Colour	Black
Width	563 mm
Depth	563 mm
Height	15 mm
Threaded connector	M20 female
Weight	13.8 kg



## LS SUPER TB 01

### SUPER MINI T-BAR FOR 35 MM TRIPODS

If you are a rental or installation company, DJ or solo entertainer, you have almost certainly experienced this or a similar situation: You need two spotlights to illuminate a specific area. As a professional, you aspire to make your construction discreet and attractive. Ideally it should not attract attention. There are slimline, elegant stands for this, such as the LS 331 B from Gravity. However, if you install a standard T-bar, the combination appears clumsy and oversized. You don't need a clavilux, just two spots.

The LS SUPER TB 01 Super Mini T-Bar provides the appropriate solution for this problem: With its elegant construction and adjustable width of 390-570 mm, it blends seamlessly into any environment, even museums and galleries. Thanks to the 17-mm TV spigot insert, lamps can be easily clicked into position, removing the tedious requirement of securing them with screws and wing nuts. Its flexible design enables lamps to be attached upright on the bar or suspended from it. However, despite its slimline elegance, there has been no compromise to the ruggedness of the LS SUPER TB 01: Maximum symmetrical load capacity is 20 kg per side. Spigot interval is adjustable from 330-515 mm. And if you need another spot or two, extra spigot inserts can be installed in the additional mounting holes.

As you are probably already aware, ergonomic locking screws, interchangeable colour rings and high-quality workmanship come as standard with all Gravity products. The integrated Allen key holder is a small extra feature that makes this T-bar even more user-friendly.



Product number	GLSSUPERTB01
Product type	Lighting stands
Type	Stands and tripod accessories
Material	Die-cast aluminum, steel
Surface	Powder coated
Colour	Black
Fitting	Clamping screw 36 mm
Length	390 - 570 mm
Stud spacing	330 - 515 mm
Max. load capacity	2 x 20 kg, balanced
Weight	1,56 kg

# ACCESSORIES LIGHTING STANDS



## LS TB 01

### UNIVERSAL T-BAR FOR 35 MM STANDS

This universal crossbar quickly converts stands with a 35 mm tube diameter into light stands. It is made with light but robust aluminium and is installed quickly and safely using the robust flange with ergonomic adjustment screw.



Product number	GLSTB01
Product type	Stands and tripod accessories
Type	Lighting stands
Colour	Black
Material	Die-cast aluminum
Surface	Powder coated
Fitting	36 mm clamp
Suitable for tube diameter	35 mm
Length	1235 mm
Max. load capacity	50 kg
Weight	1.7 kg

## LS OP 1

### REMOTE OPERATING POLE FOR SPOTLIGHTS

Anyone who works as a lighting technician in theatres, TV studios, congress centres or other production venues knows: the optimal illumination of a stage is precision work. At the same time, the tight schedules of a production rarely allow for fetching a ladder every time to manually adjust static spotlights high up in the rig - not to mention the safety risk for the people on site.

With the LS OP 1, Gravity® has a solution for these situations in its portfolio. The extendable operating pole enables the alignment of installed spotlights at great heights. The adjustment options include the pan and tilt angle, as well as focus adjustment (Pan/Tilt/Focus) via standard bells and the folding of barndoors.

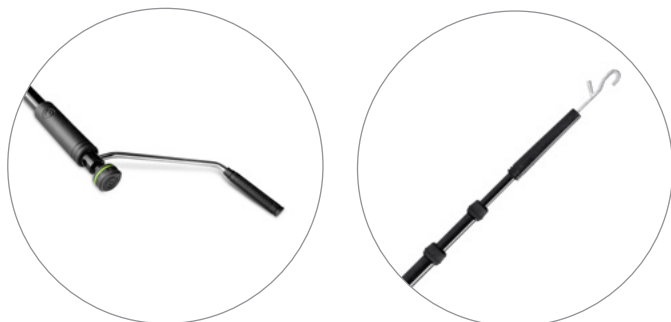

Product number	GLSOP1
Product type	Other lighting accessories
Type	Operating pole
Pole material	Aluminum
Colour	Black
Poles diameter	28 - 24 - 20 - 16 mm
Extension min.	6400 mm
Extension max.	2000 mm
Number of extensions	3
Sleeves material	Rubber
Crank material	Steel
Handle material	Plastic
Hook material	Steel
Transport length	2000 mm
Interchangeable rings	1 x 25 mm
Black ring pack included	Yes
Weight	2 kg



# ACCESSORIES LIGHTING STANDS

## PAD SET 2

### PIPE AND DRAPE CURTAIN SYSTEM INCL. CURTAIN

The Gravity® Pipe and Drape curtain system offers an innovative solution for musicians, bands, event technicians, theatres, exhibitors and stand builders. It enables swift and efficient room structuring, area partitioning, wall suspension, or walkway delineation. Utilising the PAD SET 2, consisting of the PAD A adapter, the PAD T telescopic pole and the PAD C B 1 Molton curtain, standard speaker or lighting stands with 35 mm mounts can seamlessly transform into comprehensive pipe and drape setups with minimal effort. Simply place the PAD A on to the stand and attach the telescopic pole by inserting its mounting bolts into the adapter's holes. The Molton curtain can then be effortlessly affixed to the crossbar.

Constructed from steel and plastic, the PAD A features an internal diameter of 36 mm, perfectly suited for accommodating a 35 mm stand. It boasts four fixing holes on the top, enabling the mounting of up to four PAD T telescopic poles. With its convenient snap-in function for securing the telescopic pole mounting bolts, users can effortlessly and securely lock the poles in place in a matter of seconds.

Crafted from aluminium, the PAD T telescopic pole extends from 190 cm to 350 cm, enabling customisable system widths. Featuring tilt joints at both ends, the pole facilitates straight-forward and adaptable assembly without requiring a ladder or assistance from others. The PAD C B 1 black Molton curtain measures 3.50 m x 2.55 m and features a convenient Velcro strip for effortless attachment to the PAD T traverse. Crafted from EURO molton, this flame-retardant curtain boasts an opacity of 320 g/m<sup>2</sup> and has a total weight of just under 3 kg.

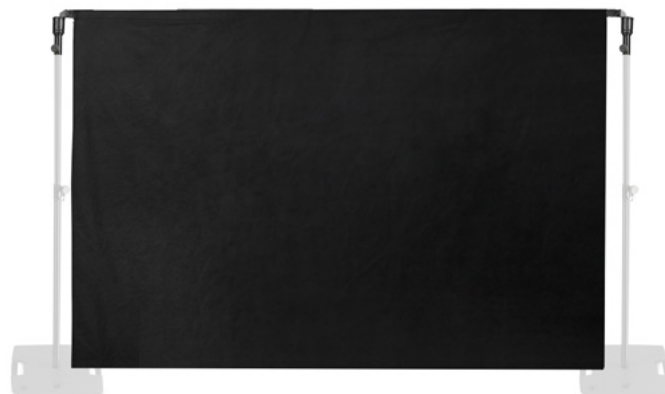

<b>Product number</b>	<b>GPAASET2</b>
Product type	Stands and tripod accessories
Type	Pipe and Drape
Weight	8.15 kg
<b>Product number</b>	<b>GPADCB1</b>
Product type	Blackout cloth
<b>Product number</b>	<b>GPADA</b>
Product type	Stands and tripod accessories
<b>Product number</b>	<b>GPADT</b>
Product type	Stands and tripod accessories

## PAD SET 1

### PIPE AND DRAPE SET WITHOUT CURTAIN

<b>Product number</b>	<b>GPAASET1</b>
Product type	Stands and tripod accessories
Type	Pipe and drape
Weight	4.6 kg
<b>Product number</b>	<b>GPADA</b>
<b>Product number</b>	<b>GPADT</b>



## PAD A

### 4-WAY PIPE AND DRAPE ADAPTER FOR 35 MM TRIPODS

Product number	GPADA
Product type	Stands and tripod accessories
Type	Pipe and Drape
Material	Steel / plastic
Colour	Black
Suitable for tube diameter	35 mm
Max. number of pipe fasteners	4
Weight	0.63 kg



## PAD C B 1

### MOLTON CURTAIN FOR PIPE AND DRAPE CURTAIN SYSTEM

Product number	GPADCB1
Product type	Blackout cloth
Material	36% polyester, 64% recycled cotton
Colour	Black
Width	3500 mm
Weight	320 g/m <sup>2</sup>
Weight	3.25 kg
Other features	Flame resistant (B1)



## PAD T

### HORIZONTAL TELESCOPIC POLE FOR PIPE AND DRAPE CURTAIN SYSTEM

Product number	GPADT
Product type	Stands and tripod accessories
Colour	Black
Material	Aluminum / plastic, velcro
Surface	Powder coated
Maximum length	3500 mm
Transport length	1900 mm
Max. load capacity	20 kg
Weight	3.65 kg

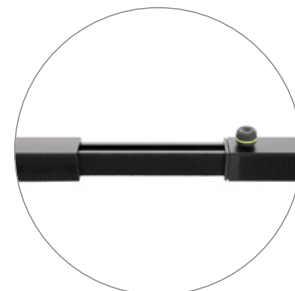
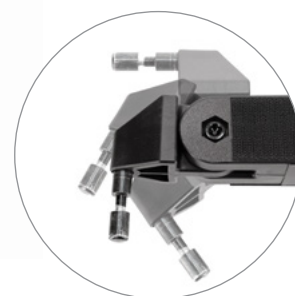







# KEYBOARD STANDS

Gravity® keyboard stands and add-on tiers are designed for safe support and easy portability. Including multi-adjustable T-style and single or double X-braced models, they are made of heavy duty steel with reinforced joints, durable powder coating and grippy pads. Gravity® keyboard stands provide easy setup and height adjustment for sitting or standing playing positions.

# KEYBOARD STANDS

## FEATURES



Black rings and pads included



VARI®-Foot  
Compensates for uneven ground



Ergonomic quick release clamp



Reinforced tubes for superior strength and longevity



## KSX 1

### KEYBOARD STAND X-FORM SINGLE

Product number	GKSX1
Product type	Stands and tripods
Type	Keyboard stands
Material	Steel
Surface	Powder coated
Colour	Black
Decks	1
Max. support depth	400 mm
Min height:	100 mm
Max height	900 mm
Max load (support)	55 kg
Interchangeable rings	1 x 15 mm, 4 x 20 mm, 4 x 30 mm
Black ring pack included	Yes
Weight	2.98 kg

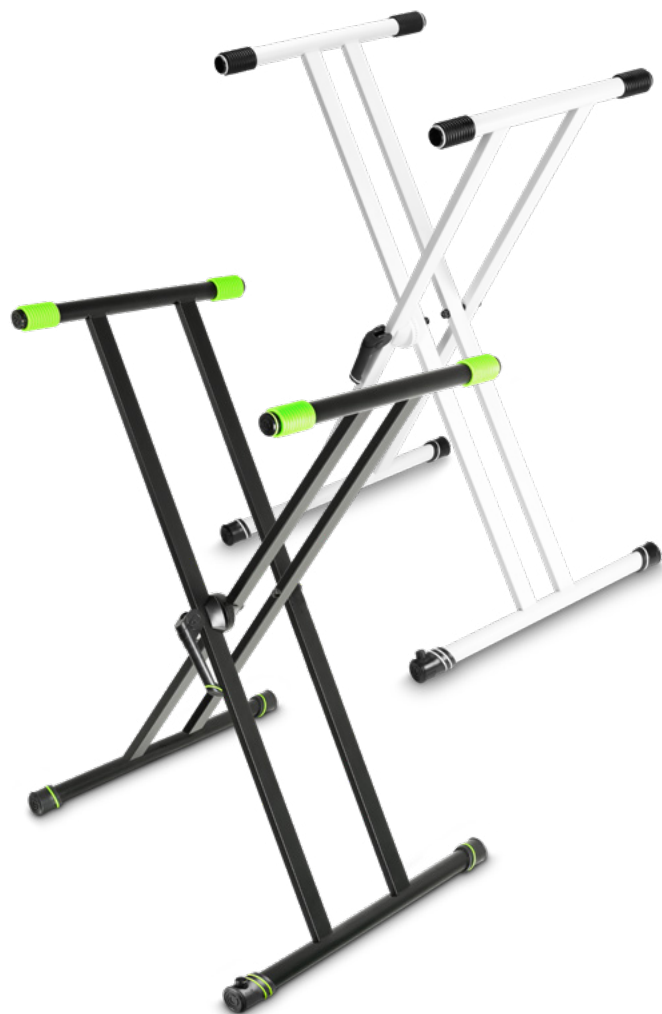

## KSX 2 / W

### KEYBOARD STAND X-FORM DOUBLE

Product number	GKSX2 / W
Product type	Stands and tripods
Type	Keyboard stands
Material	Steel
Surface	Powder coated
Colour	Black / white
Decks	1
Max. support depth	400 mm
Min height:	100 mm
Max height	900 mm
Max load (support)	65 kg
Interchangeable rings	4 x 20 mm, 4 x 30 mm, 1 x 15 mm
Black ring pack included	Yes
Weight	4.45 kg

# KEYBOARD STANDS



## KSX 2 RD

SET WITH KEYBOARD STAND X-FORM DOUBLE AND RAPID DESK

Especially on tour it is important that all instruments, equipment and accessories are compactly packed and can be easily stowed away in the bus. That's why the KSX 2 RD combines the stable Gravity KSX 2 keyboard stand with a double X-form and the Gravity Rapid Desk KS RD 1. That makes it easy for you to put up a sturdy table in a few simple steps and also to take it down into two separated flat pieces. Plus, this combination works in pretty much every situation, no matter if you're playing in the studio or practicing in the rehearsal room.

<b>Product number</b>	<b>GKSX2RD</b>
Product type	Stands and tripods
Type	Keyboard stands
Max load capacity	60 kg
Weight	11.36 kg
<b>Product number</b>	<b>GKSRD1</b>
Product type	Stands and tripod accessories
Type	Keyboard stands
<b>Product number</b>	<b>GKSX2</b>
Product type	Stands and tripods
Type	Keyboard stands



## KS RD 1

RAPID DESK FOR X-FORM KEYBOARD STANDS

Product number	GKSRD1
Product type	Stands and tripod accessories
Type	Keyboard stands
Material	Steel
Surface	Powder coated
Colour	Black
Decks	1
Max. support depth	480 mm
Max height	43 mm
Width	1000 mm
Depth	465 mm
Max load (support)	60 kg
Suitable for tube diameter	25 - 35 mm
Weight	6.62 kg



## BG RD C

COVER FOR RAPID DESK

Product number	GBGRDC
Product type	Stands and tripod accessories
Type	Cover
Cover for	Rapid desk
Colour	Black
Material	Velvet
Dimensions (W x H x D)	800 x 1000 x 480 mm
Weight	0.51 kg





SET



## KKSX 2 RD SET 1

KEYBOARD STAND X-FORM DOUBLE AND SUPPORT TABLE SET 1

<b>Product number</b>	<b>GKSX2RDSET1</b>
Product type	Stands and tripods
Weight	13.62 kg
<b>Product number</b>	<b>GKSX2RD</b>
Product type	Stands and tripods
<b>Product number</b>	<b>GBGRDC</b>
Product type	Stands and tripod accessories
<b>Product number</b>	<b>GBGX2RDB</b>
Product type	Stands and tripod accessories
Type	Transport bag
Material	1680D Nylon
Colour	Black
Thickness of the padding	10 mm
Latch	Zipper
Length of shoulder strap	1150 mm
Dimensions (W x H x D)	1050 x 96 x 550 mm
Weight	1.75 kg



SET



## KKSX 2 RD SET 2

KEYBOARD STAND X-FORM DOUBLE AND SUPPORT TABLE SET 2

<b>Product number</b>	<b>GKSX2RDSET2</b>
Product type	Stands and tripods
Type	Keyboard stands
Max. load capacity	60 kg
Weight	14.71 kg
<b>Product number</b>	<b>GKSX2RD</b>
Product type	Stands and tripods
<b>Product number</b>	<b>GBGX2RDB</b>
Product type	Stands and tripod accessories
<b>Product number</b>	<b>GLTS01B</b>
Type	Laptop stand
Material	Aluminium
Colour	Black
Surface	Powder coated
Depth	280 mm
Width	260 mm
Support width	200 mm
Support depth	145 mm
Height	270 mm
Max. board thickness for table mounting bracket	55 mm with base, 60 mm without base
Maximum load	8 kg
Weight	1.6 kg

# KEYBOARD STANDS

## KS MKS 01 B

### MULTI KEYBOARD STAND

As a musician, you know how important it is to have a reliable and versatile keyboard stand that can accommodate all of your gear. That's where the Multi Keyboardstand comes in. With four levels for keyboards, synths, workstations, grooveboxes, effects, mixers and so on you'll have plenty of space to store all of your equipment. But what really sets the Multi Keyboardstand apart is its fully adjustable supports. No matter whether it is about the distance between the supports or the tilting angle. Everything is freely adjustable, so you can customize the stand to fit your specific needs.

Not only is the Multi Keyboardstand incredibly convenient, it's also built to last. It features an additional set of higher front stoppers for larger Keyboards to keep them secure and stable, and it's made of lightweight and robust aluminium to ensure durability. Plus, it comes with a cable guide to keep your cords organized and a set of self-adhesive measuring tapes to ensure precise placement of your instruments.

In short, the Multi Keyboardstand is the perfect solution for any musician looking to streamline their setup and keep their gear organized and easily accessible. Whether you're using it in the studio or on stage, it's a must-have addition to your musical setup. Don't miss out on the convenience, versatility, and durability of the Multi Keyboardstand!



## KS MKS 01 KA B

### SUPPORT ARMS FOR MULTI KEYBOARD STAND

Product number	GKSMKS01KAB
Product type	Stands and tripods accessories
Type	Keyboard stands
Number of supports	2
Max. support depth	420 mm
Weight	1.2 kg

Product number	GKSMKS01B
Product type	Stands and tripods
Type	Keyboard stands
Material	Aluminium
Surface	Powder coated
Colour	Black
Number of supports	8
Support depth	400 mm
Adjustable support distance	75 mm to 1180 mm
Number of tiers	4
Min. tier height	180 mm
Max. tier height	1480 mm
Max. load (each tier)	25 kg
Min. anti-tipper height	25 mm
Max. anti-tipper height	40 mm
Dimensions (W x H)	1345 x 1500 mm
Depth (mm)	690 mm (940 mm when upper and lower arms are horizontal)
Interchangeable rings	16 x 25 mm
Black ring pack included	Yes
Accessories (included)	4 x Gravity SA CC 35 B cable clips, measuring tapes
Weight	13 kg





# KEYBOARD STANDS

## KS TS 01 B

### KEYBOARD STAND TABLE

This keyboard stand with table-like construction offers superior stability making it particularly suitable for heavy keyboards. It is height-adjustable in small incremental steps, making the stand suitable for both seated and standing applications. The legs can be fitted in two basic configurations – either perpendicular to the vertical structure or angled outwards slightly – the latter configuration offers additional stability and more leg room. The top rests can be adjusted to the width of the keyboard and can also be angled in small incremental steps over a range of 360 degrees. All in all, this solid steel construction comprises all features possible in such a design without compromise. For transport, both the legs and the top rest can be folded inwards, resulting in a very compact transport height. The stand includes one VARI®-Foot leveling foot to compensate for ground irregularities.



Product number	GKSTS01B
Product type	Stands and tripods
Type	Keyboard stands
Material	Steel
Surface	Powder coated
Colour	Black
Decks	1
Max. support depth	340 mm
Support arm spacing adjustment range	230 - 730 mm
Min. height	600 mm
Max. height	900 mm
Width	950 mm
Width (when folded)	1300 mm
Max load (support)	90 kg
Interchangeable rings	6 x 20 mm, 6 x 30 mm
Black ring pack included	Yes
Weight	6.9 kg



## KSX 2 T

TILTING TIER FOR GKSX KEYBOARD STANDS

Product number	GKSX2T
Product type	Stands and tripods accessories
Type	Keyboard stands
Material	Steel
Surface	Powder coated
Colour	Black
Decks	1
Max. support depth	400 mm
Support arm spacing adjustment range	490 - 740 mm
Max. height	300 mm
Max. load (support)	15 kg
Suitable for inner tube diameter	20 - 30 mm
Interchangeable rings	7 x 15 mm, 2 x 20 mm
Black ring pack included	Yes
Weight	1.8 kg

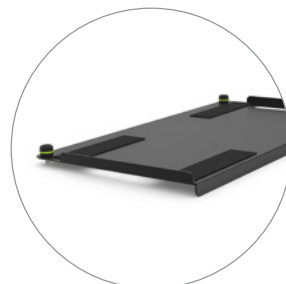

## KS LTS 2 T

UTILITY SHELF FOR SECOND TIER KEYBOARD STAND ADD-ONS

Product number	GKSLTS2T
Product type	Stands and tripods accessories
Type	Keyboard stands
Material	Steel
Surface	Powder coated
Colour	Black
Decks	1
Max. support depth	400 mm
Support arm spacing adjustment range	490 mm
Max. height	300 mm
Width	660 mm
Depth	355 mm
Max. load (support)	15 kg
Interchangeable rings	2 x 15 mm
Black ring pack included	Yes
Weight	3.8 kg







# MUSIC STANDS

Featuring friction-based height and tilt adjustment, the Gravity music stands have been designed for easy handling and stability.

## FEATURES

✓   
Black replacement rings **included**.



Aluminum plate



Foolproof operation,  
knob free tilt and height  
adjustment



Stable steel base



Stable tripod  
construction



Easy and stable plate  
mounting



Heavy duty height  
adjustment

## NS 411 / W

### CLASSIC MUSIC STAND

This music stand is based on a classic design. Attention was given to details such as the support joint which is made of die-cast material for a precise fit, the base connector and the height adjustment. Utilising the Gravity® typical ergonomic set screw knobs - made from high-grade ABS with a soft touch, non-slip thermoplastic coating and heavy duty metal joints, this stand is designed to withstand harsh treatment in the everyday life of a musician.



Product number	GNS411 / W
Product type	Stands and tripods
Type	Music stand
Music desk type	Perforated music desk
Stand material	Steel
Stand surface	Powder coated
Stand colour	Black / white
Support material	Steel
Support surface	Powder coated
Support colour	Black / white
Support width	340 mm
Support height	475 mm
Min. height	660 mm
Max. height	1200 mm
Weight	3.9 kg



# MUSIC STANDS

A music stand is quick to assemble: Fold out the legs, set it up, adjust the height, then adjust the sheet music rest - that's it! If it were just that simple... Sometimes it rattles here, then the clamping screw doesn't tighten properly and the music stand slowly but surely dips backwards. And when a whole choir or a group of music school students needs to be equipped, the details of a stand construction decide whether the performance or rehearsal goes well from the start or not...

With the NS 441 B / W folding music stand, Gravity® has thought of all these potential pitfalls. The robust tripod construction made of solid steel stands firmly on the floor and can be locked in position quickly and easily. The highlight, however, is further up: Here you will find two clamping brackets that have been specially developed for the NS 441 B / W. Instead of tediously adjusting the height of the music rest with clamping screws - and then noticing that the screw connection has been overtightened and no longer grips properly - you simply lift one or both clamps, pull out the stand and push the clamps back down. Now unfold the music stand, tilt it, tighten it and you're done!

The music stand can also be folded to a particularly compact size and safely stored in the neoprene carrying bag that comes with it. This offers two advantages: firstly, it allows you to carry several stands without them getting caught in each other or slipping out of your hands. Secondly, the neoprene material is also resistant to a little rain, so that you can save yourself the tedious task of wiping the stand dry at open-air performances.

Whether at home practising, in the rehearsal room with the band, at music school or as a choir director - with the NS 441 B / W, Gravity® offers you a flexible and stable companion that can be set up quickly and easily.

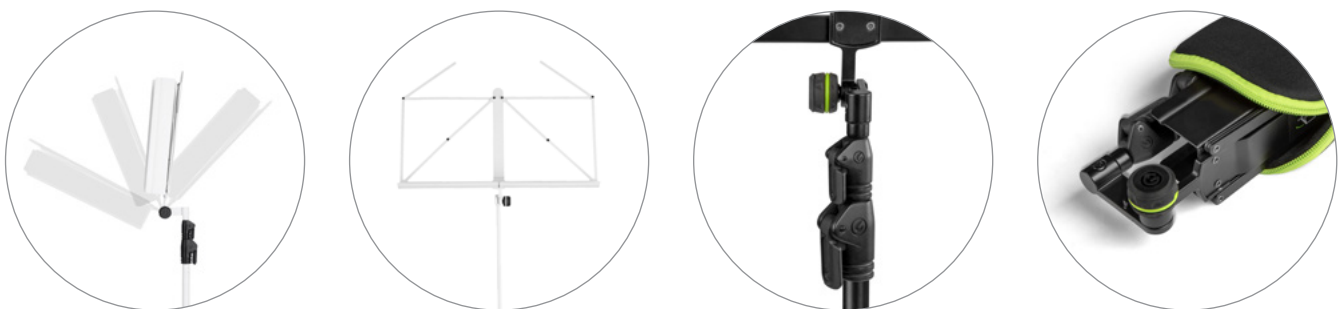



## NS 441 B / W

COMPACT FOLDING MUSIC STAND BLACK / WHITE  
INCL. CARRYING BAG

Product number	GNS441B / W
Product type	Stands and tripods
Type	Music stand
Music desk type	Folding
Stand material	Steel
Stand surface	Powder coated
Stand colour	Black / White
Support material	Steel
Support surface	Powder coated
Support colour	White
Support width	465 mm
Support height	235 mm
Min. height	670 mm
Max. height	1385 mm
Interchangeable rings	5 x 15 mm
Black ring pack included	Yes
Weight	1.2 kg



# MUSIC STANDS

The NS ORC 1 / L is a rugged orchestra-style music stand designed for ultimate handling convenience. Height and support tilt adjustment rely on frictional force and do not require any set screws. All frictional parts are engineered for zero wear. The stand of powder coated steel features a lightweight 50 x 33.5 cm aluminium support.

## NS ORC 1 ORCHESTRA MUSIC STAND



Product number	GNSORC1
Product type	Stands and tripods
Type	Music stand
Music desk type	Panel
Stand material	Aluminum
Stand surface	Chromium plated, powder coated
Stand colour	Chromium, black
Support material	Aluminum
Support surface	Powder coated
Support colour	Black
Support width	500 mm
Support height	335 mm
Min. height	640 mm
Max. height	1200 mm
Transport length	1180 mm
Max. load capacity	2.5 kg
Interchangeable rings	1 x 20 mm
Black ring pack included	Yes
Weight	2.6 kg

## NS ORC 1 L

### TALL ORCHESTRA MUSIC STAND



Product number	GNSORCTL
Product type	Stands and tripods
Type	Music stand
Music desk type	Panel
Stand material	Steel
Stand surface	Chromium plated, powder coated
Stand colour	Chromium, black
Support material	Aluminum
Support surface	Powder coated
Support colour	Black
Support width	500 mm
Support height	335 mm
Height	335 mm
Min. height	655 mm
Max. height	1500 mm
Transport length	1195 mm
Max. load capacity	2.5 kg
Black ring pack included	Yes
Weight	2.86 kg





# GUITAR STANDS

With guitar racks for multiple instruments, folding stands and wall mount hangers Gravity® has got guitar and bass players covered. Smart details such as our ingenious "Neck Hug" yoke mechanism and specially formulated rubber padding ensure your instrument stays where you put it. Gravity® guitar stands are suitable for acoustic, electric and bass guitars.





# GUITAR STANDS



## FEATURES



Folds up flat for transport and storage



Adjustable yokes with rubber padding



Straightforward, rock solid construction



Foam padding

## VARI®-G

### GUITAR RACKS FOR 3 TO 9 INSTRUMENTS

Designed for all acoustic, electric and bass guitars, Gravity® guitar racks are available in four versions accommodating 3, 5, 7 or 9 instruments. They are made of heavy-duty steel tubing with a black powder coating finish. Holding the necks firmly and securely the adjustable soft touch yokes are padded and detachable. The rails supporting the guitar bodies are covered in specifically formulated foam to prevent dents and scratches. Quick to set up and space saving, the Gravity® guitar racks fold up flat for easy transport and storage.

\*Not suitable for long-term use with guitars that have a nitro lacquer finish.

Product number	GGSMG03	GGSMG05	GGSMG07	GGSMG09
Product type	Stands and tripods	Stands and tripods	Stands and tripods	Stands and tripods
Type	Guitar stand	Guitar stand	Guitar stand	Guitar stand
Material	ABS plastic, TPU, EVA, steel	ABS plastic, TPU, EVA, steel	ABS plastic, TPU, EVA, steel	ABS plastic, TPU, EVA, steel
Surface	Powder coated, soft-touch	Powder coated, soft-touch	Powder coated, soft-touch	Powder coated, soft-touch
Colour	Black	Black	Black	Black
Suitable for	Acoustic guitars, bass guitars, electric guitars	Acoustic guitars, bass guitars, electric guitars	Acoustic guitars, bass guitars, electric guitars	Acoustic guitars, bass guitars, electric guitars
Number of guitars	3	5	7	9
Height	780 mm	780 mm	780 mm	780 mm
Depth	445 mm	445 mm	445 mm	445 mm
Dimensions when folded (W x H x D)	400 x 780 x 80 mm	600 x 780 x 80 mm	820 x 780 x 80 mm	1040 x 780 x 80 mm
Interchangeable rings	4 x 25 mm, 2 x 20 mm	4 x 25 mm, 2 x 20 mm	4 x 25 mm, 2 x 20 mm	4 x 25 mm, 2 x 20 mm
Black ring pack included	Yes	Yes	Yes	Yes
Weight	2.85 kg	3.2 kg	3.9 kg	4.8 kg

# GUITAR STANDS



## FEATURES



Folds up flat for transport and storage



Soft rubber backrest and EVA padding



Straightforward, rock solid construction



Two angles of splay

## SOLO-G

### A-FRAME GUITAR STANDS FOR ACOUSTIC AND CLASSICAL GUITARS

The solo-G series consists of 3 stands for acoustic and classical guitars, for electric and bass guitars and a universal design that accommodates most body shapes. The A-frame stands are made of heavy-duty steel tubing with black powder coating finish, soft rubber backrest and EVA support arm padding to protect the instrument's finish and non-slip rubber feet. Providing two splay angle options, the tilt back Solo-G design folds up to compact dimensions nicely for easy portability.

\*Not suitable for long-term use with guitars that have a nitro lacquer finish.

---

Product number	GGSA01A	GGSA01E	GGSA01U
Product type	Stands and tripods	Stands and tripods	Stands and tripods
Type	Guitar stands	Guitar stands	Guitar stands
Material	Steel	Steel	Steel
Surface	Powder coated	Powder coated	Powder coated
Colour	Black	Black	Black
Suitable for	Acoustic guitars	Electric guitars and bass guitars	Acoustic guitars, electric guitars and bass guitars
Interchangeable rings	4 x 25 mm	4 x 25 mm	4 x 25 mm
Weight	1.21 kg	1.3 kg	1.3 kg

# GUITAR STANDS

If you're looking for a way to make your guitar collection appear more inspiring, then let the Gravity GLOW STAND® light the way – because it gives your creative space an incredible dose of atmosphere and ambience, setting the perfect mood for you to make your music. But what really sets the guitar GLOW STAND® apart is its magnificent integrated lighting system. Each stand features adjustable ambient LED lighting that allows you to set the perfect mood with your choice of colour and brightness. Whether you're at home, in the studio, or on stage, you can create a captivating ambience that highlights the beauty of your instrument. Simply cycle through the colours by touching the unique responsive panels at the front of the stand base. And best of all, the GLOW STAND® remembers your chosen colour settings each time you switch it off.

The Guitar GLOW STAND® also features an adjustable front spotlight, which can be tilted to accentuate the intricate details of your guitar, elevating it to a true work of art!

Featuring a wide range of colours, the Guitar GLOW STAND® is sure to inspire you everytime you enter your music making space.

\*Not suitable for long-term use with guitars that have a nitro lacquer finish.

## GS LS A 01 B

### GUITAR GLOW STAND® A-FRAME

The Gravity GS LS A 01 B Guitar GLOW STAND® is an illuminated guitar stand that gives your electric guitar or bass maximum support and at the same time highlights it with colour.

It holds your guitar or bass securely and safely, and its soft support surfaces ensure that your musical instrument remains in perfect condition. In addition, the GLOW STAND® has a foam insert at the bottom that can be removed to provide more stable support for electric guitars and basses with strap pins and/or strap locks.



Product number	GGSLSA01B
Product type	Stands and tripods
Type	Guitar stand
Material	ABS plastic, metal
Colour	Black
Suitable for	Bass guitars, guitars
Colour of LEDs	RGB
Number of LED's	174
Switches	Colour selector, touch sensitive button
Switch levels	Colour change, dimming, off, on
Colour temperature	6000 - 6500 K
Colour rendering index (CRI)	75
Power consumption	7 W
Width	348 mm
Height	340 mm
Depth	348 mm
Weight	4.2 kg





## GS LS 01 NHB

### GUITAR GLOW STAND® NECK HUG

The Gravity GS LS 01 NHB Guitar GLOW STAND® is an illuminated guitar stand that gives your acoustic guitar, electric guitar or bass maximum support and at the same time highlights it with colour.

The clever "neckhug" mechanism secures the guitar at the nut against slipping and opens automatically when the instrument is lifted out of the stand. In this way, it holds your guitar or bass safely and securely and, with its soft support surfaces, ensures that your musical instrument remains in perfect condition.

Product number	GGSL01NHB
Product type	Stands and tripods
Type	Guitar stand
Material	ABS plastic, metal
Colour	Black
Length of light bar	900 mm
Suitable for	Bass guitars, guitars
Colour of LEDs	RGB
Number of LED's	256
Switches	Colour selector, touch sensitive button
Switch levels	Colour change, dimming, off, on
Colour temperature	6000 - 6500 K
Colour rendering index (CRI)	75
Power consumption	9 W
Width	348 mm
Height	965 - 1065 mm
Depth	348 mm
Scope of delivery	Allen key, extension aluminum tube
Weight	5.4 kg

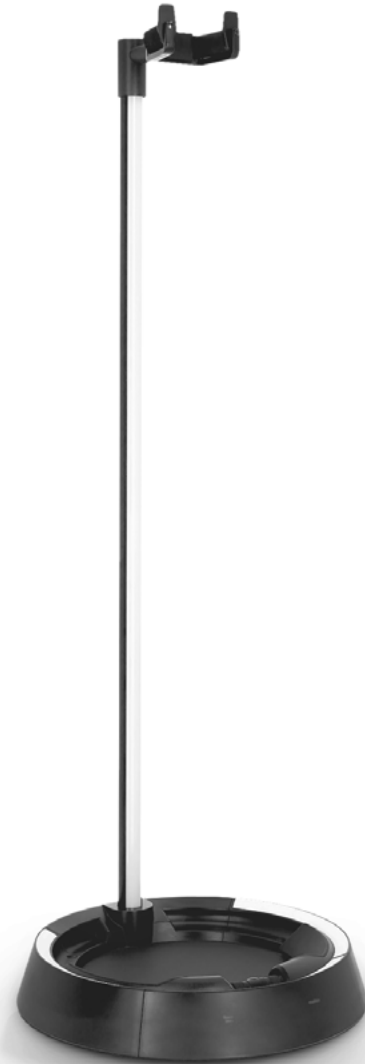

# GUITAR STANDS

## GS 01 NHB

### FOLDABLE GUITAR STAND WITH NECK HUG

The GS 01 NHB is a stable and elegant guitar stand for acoustic, electric and bass guitars. It can be adjusted in height up to 108 cm and folds up. The clever "neck hug" mechanism secures the guitar automatically in the neck fork from slipping and opens automatically when the instrument is lifted from the tripod. The soft padding protects the guitar from scratches and does not damage the paint.

\*Not suitable for long-term use with guitars that have a nitro lacquer finish

Product number	GG01NHB
Product type	Stands and tripods
Type	Guitar stand
Material	Steel
Colour	Black
Surface	Powder coated
Suitable for	Electric guitars, acoustic guitars, bass guitars
Number of guitars	1
Width	500 mm
Min. height	680 mm
Max. height	1080 mm
Depth	400 mm
Interchangeable rings	4 x 25 mm
Black ring pack included	Yes
Weight	1.64 kg



Automatically secures the guitar



Innovative neck hug technology



Quick release clamp for easy setup and adjustment



Foam padding

## GS MS 08

### TRAVELER GUITAR HOLDER

The GS MS 08 is a universal hanger for acoustic guitars, electric guitars and basses. It can be mounted on any tripod stand/pole which has a diameter of 15-35mm, and its self-adjusting holder accommodates any headstock size and shape. The GS MS 08 is coated with a specially formulated rubber that provides a secure hold for the instrument, yet does not mar the finish.

\*Not recommended for guitars with a nitro lacquer finish.



Product number	GGSMS08
Product type	Stands and tripods
Type	Guitar stand
Material	Steel, plastic
Colour	Black
Surface	Rubber coated
Suitable for	Electric guitars, acoustic guitars, bass guitars
Number of guitars	1
Suitable for mounting on	Microphone stands, speaker tripod
Suitable for tube diameter	15 mm - 35 mm
Weight	0.23 kg



Easy mounting on  
almost all stands

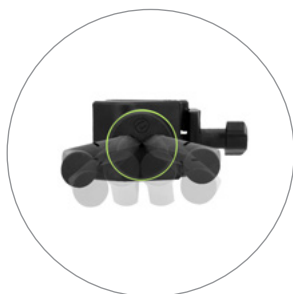

Suitable for all  
headstock shapes

# GUITAR STANDS

## GS 01 WMB

### WALL MOUNT GUITAR HANGER WITH NECK HUG

This universal wall mount hanger for acoustic, electric and bass guitars features Gravity's smart „neck hug” technology. It automatically secures the neck in the yoke to prevent falling out. The locking wings open again when the instrument is lifted from the hanger. The yoke is coated with EVA that does not mar the finish.

\*Not suitable for long-term use with guitars that have a nitro lacquer finish.



Product number	GGS01WMB
Product type	Stands and tripods
Type	Guitar stand
Material	Die-cast aluminum, plastic
Colour	Black
Surface	Powder coated
Suitable for	Acoustic guitars, bass guitars, electric guitars
Number of guitars	1
Width	90 mm
Min. height	70 mm
Depth	140 mm
Interchangeable rings	1 x 25 mm
Black ring pack included	Yes
Weight	0.25 kg

## GS 08 WMB

### WALL MOUNT GUITAR HANGER

The GS 08 WMB is a universal wall mount hanger for acoustic, electric and bass guitars. The yoke is self adjusting to accommodate any headstock. It is coated with specially formulated rubber that provides a secure grip and does not mar the finish.

\*Not suitable for long-term use with guitars that have a nitro lacquer finish.



Product number	GG08WMB
Product type	Stands and tripods
Type	Guitar stand
Material	Steel, plastic
Colour	Black
Surface	Rubber coated
Suitable for	Electric guitars, acoustic guitars, bass guitars
Number of guitars	1
Interchangeable rings	1 x 25 mm
Weight	0.17 kg



# GUITAR STANDS



## GS WMB 01 EB

WALL-MOUNT FOR PRESENTATION OF ELECTRIC GUITARS

This horizontal guitar holder is designed for eye-catching display of your guitar on walls. The low-profile construction features easy angle adjustment without slippage and padded self-balancing cradles that hold the guitar body and neck securely.



Product number	GGSWMB01EB
Product type	Stands and tripods
Type	Guitar stand
Material	Plastic, aluminum, steel
Colour	Black
Surface	EVA
Main arm length	565 mm
Suitable for	Electric guitars
Max. instrument depth	70 mm
Number of guitars	1
Interchangeable rings	1 x 15 mm, 2 x 30 mm
Black ring pack included	Yes
Weight	1.9 kg

## GS WMB 01 AB

WALL-MOUNT FOR PRESENTATION OF ACOUSTIC GUITARS

This horizontal guitar holder is designed for eye-catching display of your guitar on walls. The low-profile construction features easy angle adjustment without slippage and padded self-balancing cradles that hold the guitar body and neck securely.



Product number	GGSWMB01AB
Product type	Stands and tripods
Type	Guitar stand
Material	Plastic, aluminum, steel
Colour	Black
Surface	EVA
Main arm length	565 mm
Suitable for	Acoustic guitars
Max. instrument depth	120 mm
Number of guitars	1
Interchangeable rings	1 x 15 mm, 2 x 30 mm
Black ring pack included	Yes
Weight	1.9 kg



## GS FB 01

### GUITAR FOOTREST

Designed to support the proper posture for playing classical guitar, this Gravity® footrest offers 6 adjustable height levels from 180 to 255 mm to perfectly adapt to any player. The rubber tipped feet are angled outwards to increase stability and prevent tipping over, and the extra wide construction with non-slip rubber pad provides a secure grip of any foot.



Product number	GGSF01
Product type	Guitar accessories
Material	Rubber, steel
Colour	Black
Height adjustment	6 increments
Height	180 - 255 mm
Width	124 mm
Length	300 mm
Weight	0.8 kg





# MULTIMEDIA EQUIPMENT

Gravity® multimedia stands facilitate integrating your mobile devices into your performance. Smart designs that are highly adjustable accommodate laptops, tablets, smartphones or controllers for convenient operation and easy reach where you need them. Featuring reliable rock-solid construction and thoughtful details, Gravity® multimedia stands stow away with compact dimensions for easy transport.

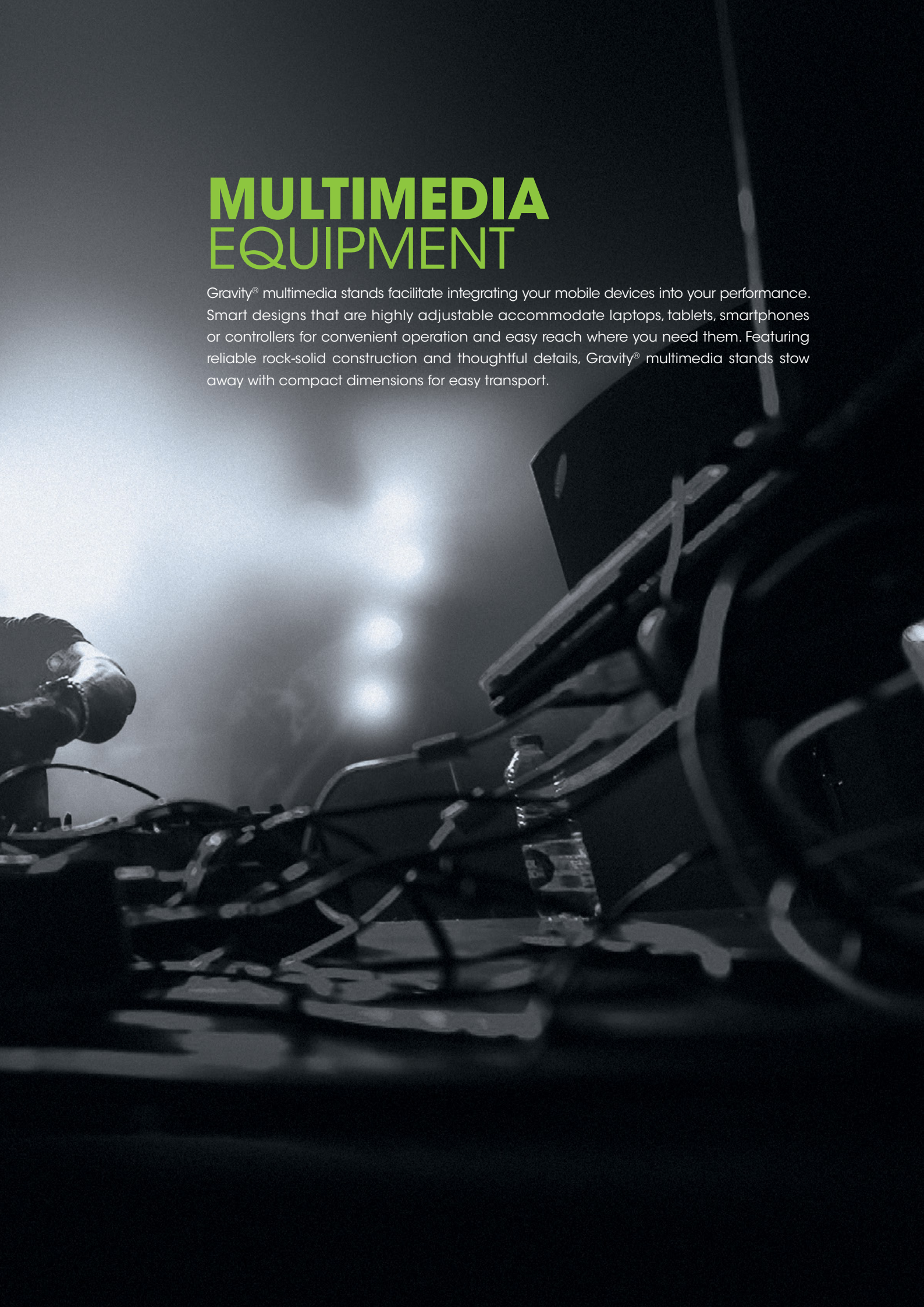

# MULTIMEDIA EQUIPMENT



Watch the video



## FEATURES



Laptop tray  
with adjustable  
holding pins



Speaker tray:  
adjustable in height, tilt  
and rotation



The entire desk  
is height  
adjustable



Levelling feet  
for uneven  
floors



## FDJT 01

### DJ DESK WITH ADJUSTABLE LAPTOP AND LOUDSPEAKER TRAYS

Creativity has no limits, but workspace certainly does. A place where you can unfold without limits is the Gravity® FDJT 01 DJ desk. On it you keep your set-up compact and always ready for the moment when inspiration strikes.

Your trusty monitors can be placed on the height-adjustable, 360° rotatable and 15° tiltable trays. The precise positioning and inclination of your loudspeakers is made much easier for you by a precise scale on the tubes.

Your laptop is enthroned at the heart of your set-up in the middle of the table, held firmly in place by the integrated pins so that even if tilted extremely, it is always secure. Both loudspeaker and laptop trays can be adjusted precisely along the rear rail of the Gravity® FDJT 01 DJ Desk by shifting them to the left or right.

You will have no trouble adapting the desk to your individual height. It can be set between 680 mm and 1090 mm and offers you plenty of space for your equipment - with a usable depth of 500 mm and a width of 1190 mm.

More stability is provided by the adjustable levelling feet, which compensate for any unevenness of the floor, and the mountable cross bar, which significantly strengthens the table.

Product number	GFDJT01
Product type	Studio & recording equipment tables
Type	DJ table
Material	Steel
Surface table	Powder coated
Surface speaker tray	EVA padded
Surface laptop tray	Powder coated
Colour	Black
Max. support depth table	500 mm
Max. support depth speaker tray	245 mm
Max. support depth laptop tray	330 mm
Min. height table	680 mm
Max. height table	1090 mm
Min. height speaker tray	263 mm
Max. height speaker tray	358 mm
Width table	1190 mm
Width speaker tray	250 mm
Width laptop tray	480 mm
Depth table	560 mm
Depth speaker tray	250 mm
Depth laptop tray	330 mm
Max. load table	50 kg
Max. load speaker tray	15 kg
Tilt angle speaker tray	+/- 15°
Rotating range speaker tray	360°
Weight	25.24 kg



## XSP 10130

### MOUNTING / RACK BRACKET FOR GRAVITY® DJ DESK

Product number	GXSP10130
Product type	Rack angle for DJ-desk
Colour	Black
Surface	Powder coated
Height	1 HE
Diameter Scope of delivery	2 rack angles
Weight	0.22 kg



# MULTIMEDIA EQUIPMENT



## FT 01

### DJ DESK

The DJ Desk offers enough space to place two decks and a mixing console or your DJ controller. Your performance setup with samplers, sequencers and synthesizers will also find enough room thanks to a surface depth of 50 cm and a width of 119 cm.

In case you need additional space, simply expand the Gravity® DJ Desk with an optionally available laptop holder or two studio monitor holders. The rear rail also offers further flexible expansion options that are tailored to your individual needs as a DJ, producer or instrumentalist. You will have no trouble adapting the desk to your individual height. It can be set between 68 cm and 109 cm.

More stability is provided by the adjustable levelling feet, which compensate for any unevenness of the floor, and the mountable cross bar, which significantly strengthens the table.

Product number	GFT01
Product type	Studio & recording equipment tables
Type	DJ table
Material	Steel
Surface	Powder coated
Colour	Black
Max. support depth table	500 mm
Min. height	680 mm
Max. height	1090 mm
Width	1190 mm
Depth	560 mm
Max. load capacity	50 kg
Weight	16.5 kg



## BG DC 1

### MULTIFUNCTIONAL DESK PAD 119 X 50 CM\*

The Gravity® BG DC 1 is a premium, multifunctional desk pad designed for DJ desks, office desks, and other work surfaces. Measuring 119 cm x 50 cm\* with a 5-mm-thick neoprene layer, it fits perfectly with the Gravity® FDJT 01 and FT 01 DJ desks.

Durable and hard-wearing, the BG DC 1 not only protects your surface, but also provides a comfortable, padded work surface with a pleasantly warm feel. Its special surface is water-repellent, skin-friendly, and non-reflective, allowing your mouse to glide smoothly with speed and precision, making it an ideal XXL mouse pad.

Cleanly finished edges prevent fraying, and the non-slip underside ensures a firm grip on almost any surface, keeping the BG DC 1 well in place.

\*Size may vary slightly.

Product number	GBGDC
Product type	Stands and tripod accessories
Type	Cover for DJ table
Material	Neoprene
Colour	Black
Length	1190 mm*
Width	500 mm*
Height	5 mm
Weight	0.57 kg



## FT 01 LTT B

### FLEXIBLE LAPTOP TRAY FOR DJ DESK

The practical laptop tray with adjustable holding pins extends the functionality of your Gravity® DJ desk (FT 01) and ensures the best view of your laptop. The laptop tray FT 01 LTT B is continuously height-adjustable, rotatable by 360° and tiltable by 15°.

With the adjustable holding pins, the tray holds your laptop, tablet, effects or mixing console securely in place, even when tilted, and thanks to the sophisticated rail system on the DJ desk (FT 01), the laptop tray can also be moved horizontally.

Product number	GFT01LTTB
Product type	Stands and tripods
Type	Laptop stand
Material	Steel
Surface	Powder coated
Colour	Black
Width adjusting jaws	40 mm
Width spacing between adjusting pins min.	120 mm
Width spacing between adjusting pins max.	425 mm
Height spacing between adjusting pins to adjusting jaws min.	117 mm
Height spacing between adjusting pins to adjusting jaws max.	250 mm
Width spacing between adjusting jaws min.	130 mm
Width spacing between adjusting jaws max.	360 mm
Support width	480 mm
Tray height	330 mm
Interchangeable rings	5 x 15 mm, 1 x 25 mm, 1 x 30 mm
Black ring pack included	Yes
Accessories (included)	2 x adj. jaws, 2 x adj. pins, 4 x locking screws
Weight	2.5 kg



## FT 01 MT B

### FLEXIBLE STUDIO MONITOR TRAY FOR DJ DESK

The practical studio monitor trays extend the functionality of your Gravity® DJ Desk (FT 01) and allow you to perfectly set up your trusty studio monitors.

The FT 01 MT B studio monitor trays are continuously height-adjustable, rotatable by 360° and tiltable by 15°. Precise positioning and tilting of the loudspeakers is made much easier thanks to a scale on the tubes.

To ensure that no annoying frequencies are transmitted from the studio monitors to your DJ Desk, the trays are coated with EVA pads and the front anti-tip device holds your loudspeakers securely in position, even when they are tilted sharply.

Thanks to the ingenious rail system on the DJ desk, the studio monitor trays can also be moved horizontally.

Product number	GFT01MTB
Product type	Stands and tripods
Type	Speaker stands
Material	Steel
Surface	Powder coated
Colour	Black
Min. height	250 mm
Max. height	350 mm
Tilt angle	+/- 15 °
Rotation	360 °
Bearing surface	250 x 250 mm, EVA padded
Height adjustment	Adjusting screw
Max. load	15 kg
Interchangeable rings	1 x 15 mm, 1 x 25 mm, 1 x 30 mm
Black ring pack included	Yes
Weight	3.6 kg

# MULTIMEDIA EQUIPMENT

## LTS T 01

### LAPTOP STAND WITH ADJUSTABLE HOLDING PINS

The LTS T 01 is a laptop stand with a tripod leg construction which has been designed for maximum mobility and stability on stage. The stand's height can be gradually adjusted from 750 mm to 1.320 mm, allowing you to adjust it perfectly to your needs - whether you're standing or sitting. The tray panel features four adjustable holding pins to ensure the safe and secure positioning of laptops, DJ-controller and other equipment.



Product number	GLTST01
Product type	Stands and tripods multimedia equipment
Type	Laptop stand
Support material	Steel
Tubing material	Aluminum
Surface	Powder coated
Colour	Black
Width adjusting jaws	40 mm
Width spacing between adjusting pins min.	120 mm
Width spacing between adjusting pins max.	425 mm
Height spacing between adjusting pins to adjusting jaws min.	117 mm
Height spacing between adjusting pins to adjusting jaws max.	250 mm
Width spacing between adjusting jaws min.	130 mm
Width spacing between adjusting jaws max.	360 mm
Tray width	480 mm
Tray height	330 mm
Min height	750 mm
Max height	1320 mm
Transport length	665 mm
Height adjustment	Adjusting screw with safety pin
Base type	Leg joint
Base material	Die-cast aluminum
Tubing diameter	35 mm
Max. load	15 kg
Interchangeable rings	2x 30 mm
Black ring pack included	Yes
Weight	4.02 kg



## LTST 02 B / W

### UNIVERSAL LAPTOP STAND WITH ADJUSTABLE HOLDING PINS AND STEEL BASE

The LTS T 02 B / W is a universal laptop stand that's bound to win you over as a flexible portable tool for setting up mobile performance rigs in a variety of situations. Its height-adjustable tray panel, which offers enough space to accommodate all common 12" to 17" laptops can be adjusted to any angle — horizontally and vertically. The four adjustable holding pins ensure the safe and secure positioning of laptops and tablets.



Product number	GLTST02B / W
Product type	Stands and tripods multimedia equipment
Type	Laptop stand
Support material	Steel
Tubing material	Steel
Surface	Powder coated
Colour	Black / white
Width adjusting jaws	40 mm
Width spacing between adjusting pins min.	120 mm
Width spacing between adjusting pins max.	425 mm
Height spacing between adjusting pins to adjusting jaws min.	117 mm
Height spacing between adjusting pins to adjusting jaws max.	250 mm
Width spacing between adjusting jaws min.	130 mm
Width spacing between adjusting jaws max.	360 mm
Tray width	480 mm
Tray height	330 mm
Min height	790 mm
Max height	1200 mm
Transport length	790 mm
Height adjustment	Adjusting screw with safety pin
Dimensions Base (W x H x D)	565 x 20 x 330 mm
Base material	Steel
Base weight	8.2 kg
Max. load capacity	15 kg
Interchangeable rings	2 x 30 mm, 1 x 25 mm, 4 x 15 mm
Black ring pack included	Yes
Weight	11.76 kg



# MULTIMEDIA EQUIPMENT

## LTS 01 B

### ADJUSTABLE LAPTOP AND CONTROLLER STAND

Revolutionizing the concept of notebook supports, this stand offers the best of all worlds. It is extremely stable yet lightweight and folds to a compact transport size within seconds. Also suitable for controllers the stand features eccentric locking clamps that facilitate quick and secure angle adjustment of both the non-slip rubberized support and base for optimum ergonomic setup. It comes with a table C-clamp and a middle tray which elegantly lock onto the pillar.

Product number	GLTS01B
Product type	Stands and tripods
Type	Laptop stand
Material	Aluminum
Surface	Powder coated
Colour	Black
Depth	280 mm
Support depth	145 mm
Width	200 mm
Support width	200 mm
Height	270 mm
Max. board thickness for table mounting bracket	55 mm with base, 60 mm without base
Maximum load	8 kg
Weight	1.6 kg



## LTS 01 C B

### HEIGHT ADJUSTABLE LAPTOP AND CONTROLLER STAND

Product number	GLTS01CB
Product type	Stands and tripods
Type	Laptop stand
Material	Steel
Surface	EVA, powder coated
Colour	Black
Depth	310 mm
Width	255 mm
Min. height	225 mm
Max. height	370 mm
Maximum load	8 kg
Interchangeable rings	4 x 15 mm
Black ring pack included	Yes
Weight	2.4 kg



LAPTOP IS NOT INCLUDED



## LTS 01 B SET 1

ADJUSTABLE STAND FOR LAPTOPS AND CONTROLLERS INCLUDING NEOPRENE PROTECTION BAG

Featuring a revolutionary patented design, this laptop stand is extremely stable yet lightweight and easily portable. It accommodates all sizes from 12" to 17", controllers such as Launchpad, Maschine or Push 2 and folds to compact transport dimensions in seconds. Eccentric locking clamps facilitate quick and secure tilt adjustment of both the non-slip rubberized support and base for optimum ergonomic setup. The set includes a neoprene protection bag to protect the laptop stand from dirt and scratches.



## BG LTS 01 B

TRANSPORT BAG FOR GRAVITY® LAPTOP STAND

This lightweight transport bag protects your laptop stand from dirt and scratches during transport and storage. It is made of durable, water-repellent neoprene fabric and features a rugged two-way zipper for easy access.



Product number	GLTS01BSET1
Product type	Stands and tripods
Type	Laptop stand
Material	Aluminum
Surface	Powder coated
Colour	Black
Depth	280 mm
Support depth	145 mm
Width	260 mm
Support width	200 mm
Height	270 mm
Max. board thickness for table mounting bracket	55 mm with base, 60 mm without base
Maximum load	8 kg
Weight	1.2 kg
Additional information	With high quality protective neoprene carry bag

Product number	GBGLTS01B
Product type	Stands and tripod accessories
Type	Transport bag
For number of stands	1
Colour	Black
Material	Neoprene
Thickness of the padding	1 mm
Latch	Double zip
Width	300 mm
Height	350 mm
Depth	20 mm
Weight	0.1 kg

# MULTIMEDIA EQUIPMENT

## MA VARIARM M 14

VERSATILE SWIVEL ARM WITH CENTRAL LOCKING MECHANISM - 1/4" MEDIUM

With the VARI®-ARM M 14, Gravity® has created such an universal tool that allows you to use a wide variety of equipment - from an action cam to a mobile recorder - almost anywhere and in any direction in a matter of seconds.

The VARI®-ARM M 14 is an innovative mounting arm with three joints that allow you to move your equipment freely and precisely into any desired position. Its main feature: Only one adjusting screw is needed to lock and unlock all three joints. As soon as you have found your desired position, you tighten the locking screw and the position of the VARI®-ARM M 14 is held tight and safe.

Both ends of the VARI®-ARM M 14 have 1/4" threads on which you can attach almost any camera, handheld recorder or smartphone holder on the market. You can then screw the VARI®-ARM to a Super Clamp with a 1/4" mount and fix your equipment to a truss in the studio or on stage.



Product number	GMAVARIARM14
Product type	Microphone accessories
Type	Vari-Arm
Material	Steel
Colour	Black
Threaded connector	1/4"
Interchangeable rings	1 x 15mm
Black ring pack included	Yes
Dimensions (L x H x W)	290 mm x 70 mm x 20 mm
Weight	0.29 kg

## MA VARIARM M 38

### VERSATILE SWIVEL ARM WITH CENTRAL LOCKING MECHANISM - 3/8" MEDIUM

With the VARI®-ARM M 38, Gravity® has created such a universal tool that allows you to use a wide variety of equipment - from a microphone clamp to a tablet or an action cam - almost anywhere and in any direction in a matter of seconds.

The VARI®-ARM M 38 is an innovative mounting arm with three joints that allow you to move your equipment freely and precisely into any desired position. Its main feature: Only one adjusting screw is needed to lock and unlock all three joints. As soon as you have found your desired position, you tighten the locking screw and the position of the VARI®-ARM M 38 is held tight and safe. Thanks to the 3-kilogram load capacity, you can even mount a DSLM camera including a standard lens or a heavyweight microphone such as the broadcast classic RE-20.

There is a 3/8" thread at the head of the VARI®-ARM for you to screw on a microphone clip, a pop filter and more. The included adapter (3/8" to 1/4" reduction thread) gives you complete flexibility, allowing you to use almost any camera, handheld recorder or smartphone mount on the market with the VARI®-ARM M 38. Thanks to the solid clamp at the bottom of the VARI®-ARM and its large clamping range from 15 to 35 mm, the VARI®-ARM can also be easily attached to most tables and poles (e.g. to tripods).



Product number	GMAVARIARM38
Product type	Microphone accessories
Type	Vari-Arm
Material	Steel
Colour	Black
Arm length (without clamp)	270 mm
Mounting	Microphone stand, tabletop
Threaded connector	3/8"
Fits tube diameters up to	15 mm to 35 mm
Interchangeable rings	1 x 15 mm, 1 x 25 mm
Black ring pack included	Yes
Dimensions (L x H x W)	335 x 103 x 40 mm
Weight	0.46 kg

# MULTIMEDIA EQUIPMENT

## MA VARIARM L 38

VERSATILE SWIVEL ARM WITH CENTRAL LOCKING MECHANISM - 3/8" LARGE

With the VARI®-ARM L 38, Gravity® has created such an universal tool that allows you to use a wide variety of equipment - from a microphone clamp to a tablet or an action cam - almost anywhere and in any direction in a matter of seconds.

The VARI®-ARM L 38 is an innovative mounting arm with three joints that allow you to move your equipment freely and precisely into any desired position.

Its main feature: Only one adjusting screw is needed to lock and unlock all three joints. As soon as you have found your desired position, you tighten the locking screw and the position of the VARI®-ARM L 38 is held tight and safe. The included adapter (3/8" to 1/4" reduction thread) gives you complete flexibility, allowing you to use almost any camera, handheld recorder or smartphone mount on the market with the VARI®- ARM L 38.

Thanks to the solid clamp at the bottom of the VARI®-ARM and its large clamping range from 15 to 35 mm, the VARI®-ARM can also be easily attached to most tables and poles (e.g. to tripods).



Product number	GMAVARIARML38
Product type	Microphone accessories
Type	Vari-Arm
Material	Steel
Colour	Black
Arm length (without clamp)	415 mm
Mounting	Microphone stand, tabletop
Threaded connector	3/8"
Fits tube diameters up to	15 mm - 35 mm
Interchangeable rings	1 x 25 mm
Black ring pack included	Yes
Accessories (included)	1x adapter 3/8" female to 1/4" male
Dimensions (Lx H x W)	480 mm x 83 mm x 58 mm
Weight	0.51 kg



One main adjustment screw for loosening and tightening all joints



Solid mounting clamp with a large clamping range (15-35 mm)



Incl. 1/4" reduction thread



Swivel arm for free arrangement of equipment

## MA VARIARM L TV

### VERSATILE SWIVEL ARM WITH CENTRAL LOCKING MECHANISM - 1/4" TV16 LARGE

With the VARI®-ARM L TV, Gravity® has created such a universal tool that allows you to use a wide variety of equipment - from microphone clamps to super clamps and lighting equipment - almost anywhere and in any direction in a matter of seconds.

The VARI®-ARM L TV is an innovative mounting arm with three joints that allow you to move your equipment freely and precisely into any desired position. Its main feature: Only one adjusting screw is needed to lock and unlock all three joints. As soon as you have found your desired position, you tighten the locking screw and the position of the VARI®-ARM L TV is held tight and safe.

Perfect for truss mounting:

Both ends of the VARI®-ARM L TV have a 16 mm TV spigot for attaching the VARI®-ARM to a Super Clamp. You can unscrew the two TV16 spigots. This frees up a 1/4" thread to which you can attach a microphone clamp, pop filter and more.



Product number	GMAVARIARMLTV
Product type	Microphone accessories
Type	Vari-Arm
Material	Steel
Colour	Black
Connector	1/4", TV 16
Dimensions (L x H x W)	415 mm x 58 mm x 83 mm
Weight	0.39 kg



# MULTIMEDIA EQUIPMENT

## TRAVELER SERIES

### MA T TH 01

#### TRAVELER UNIVERSAL TABLET HOLDER

You can always take the MA T TH 01 tablet holder from Gravity® with you on your travels, because it is so light and space-saving that you don't have to worry about weight or storage space.

With this tool, you can attach all common tablets - with screen sizes from 7.3 to 12.3 inches - to your microphone stand and align them flexibly. Its mounting mechanism is quick and easy to assemble and the adjustable arms ensure that your tablet is always stable and securely attached.

To ensure that your tablet never runs out of power on stage, the durable and lightweight design incorporates a handy adjustable pick-up that you can use as a power bank or even a smartphone holder.



Product number	GMA T TH 01
Product type	Stands and tripod accessories
Type	Tablet & smartphone holder
Mounting	Clamp connector
Suitable for tube diameter	10 - 35 mm
Min. device size (screen size)	7.3"
Maximum device size (screen size)	12.3"
Max. device depth	15 mm
Material	Plastic
Colour	Black
Other features	Portrait and landscape format, tilt and swivel
Accessories (included)	Adapter for square tube or table mounting included, power bank mounting bracket included (range 60 - 100 mm)
Weight	0.43 kg

## MA T TH 02

### TRAVELER UNIVERSAL TABLET HOLDER FOR STAND MOUNTING

You can always take the Gravity MA T TH 02 tablet holder with you on your travels: it's so light and space-saving that you won't have to worry about weight or storage space!

With this practical tool, you can attach and flexibly position all typical tablets (with screen sizes from 7.3" to 12.3") directly on to the 5/8" thread of your microphone stand.

The mounting mechanism is quick and easy to assemble, and the adjustable arms ensure that your tablet is always stable and securely attached.



Equipment not included

Product number	GMATTH02
Product type	Stands and tripod accessories
Type	Tablet & smartphone holder
Material	Plastic
Mounting	Clamp connector
Colour	Black
Min. device size (screen size)	7.3"
Max. device size (screen size)	12.3"
Max. device depth	15 mm
Other features	Portrait and landscape format, tilt and swivel
Weight	0.26 kg

# MULTIMEDIA EQUIPMENT

## TRAVELER SERIES

### MA T T H 02 SET 1

TRAVELER TABLET HOLDER AND MICROPHONE STAND WITH ROUND BASE

Comprised of two top-selling Gravity stalwarts – the MA T T H 02 and MS 23 – this set allows you to quickly and easily position all standard tablets (which range in screen size from 7.3" to 12.3") exactly where you need them.

The tablet holder's mounting mechanism is easy to assemble, and the adjustable arms ensure that your tablet is always securely and safely attached in position. The handle of the MS 23 microphone stand – which offers smooth adjustment alongside rugged build quality – is made of highly durable ABS and covered with a non-slip soft-touch thermoplastic coating, ensuring particularly comfortable operation.

The MA T T H 02 SET 1 is compatible with VARIWEIGHT®: Gravity's patented stability system for secure support and easy transport using insertable weight plates.

<b>Product number</b>	<b>GMATTH02SET1</b>
Product type	Stands and tripods
Type	Tablet stand
Weight	4.46 kg
<b>Product number</b>	<b>GMS23</b>
Product type	Stands and tripods
Type	Microphone stands
Tubing material	Steel
Colour	Black
Surface	Powder coated
Min. height	1000 mm
Max. height	1600 mm
Transport length	1000 mm
Height adjustment	Yes
Base type	Round base
Base material	Cast iron
Base diameter	270 mm
Base weight	3.6 kg
Interchangeable rings	1 x 20 mm
Black ring pack included	Yes
Weight	4.2 kg
<b>Product number</b>	<b>GMATTH02</b>
Product type	Stand and tripod accessories
Type	Tablet & smartphone holder
Material	Plastic
Colour	Black
Mounting	Clamp connector
Min. device size	7.3"
Max. device size	12.3"
Max. device depth	15 mm
Other features	Portrait and landscape format, tilt and swivel
Weight	0.26 kg



Equipment not included



## MA T TH 02 SET 2

### TRAVELER TABLET HOLDER AND 1-HAND MIC STAND WITH ROUND BASE

The tablet holder's mounting mechanism is easy to assemble, and the adjustable arms ensure that your tablet is always securely and safely attached in position. In addition, the MS 231 HB offers innovative, particularly comfortable one-handed height adjustment via a non-slip ergonomic grip, making it ultra-easy to operate at any time.

The MA T TH 02 SET 2 is compatible with VARIWEIGHT®: Gravity's patented stability system for secure support and easy transport using insertable weight plates.

Product number	GMATTH02SET2
Product type	Stands and tripods
Type	Tablet stand
Weight	4.66 kg
<b>Product number</b>	<b>GMS231HB</b>
Product type	Stands and tripods
Type	Microphone stands
Tubing material	Steel
Colour	Black
Surface	Powder coated
Min. height	1080 mm
Max. height	1750 mm
Transport length	1080 mm
Height adjustment	Yes
Base type	Round base
Base material	Cast iron
Base diameter	270 mm
Base weight	3.6 kg
Interchangeable rings	1x 20 mm
Black ring pack included	Yes
Weight	4.4 kg
<b>Product number</b>	<b>GMATTH02</b>
Product type	Stand and tripod accessories
Type	Tablet & smartphone holder
Material	Plastic
Colour	Black
Mounting	Clamp connector
Min. device size	7.3"
Max. device size	12.3"
Max. device depth	15 mm
Other features	Portrait and landscape format, tilt and swivel
Weight	0.26 kg



# MULTIMEDIA EQUIPMENT

## MS TBA 01

### MICROPHONE ARM

Overcome your big and small challenges in your day-to-day life as content creator or producer with the Gravity® MS TBA 01 desk-mounted microphone boom arm. With its three joints the boom arm can be placed in pretty much any position you want and its robust steel clamp lets you attach the boom arm on almost any table due to its very wide clamping range.

The microphone cable is neatly packed in the integrated cable guide so that you can quickly exchange the cable when things get a little hectic. Another special feature that Gravity® developed for the microphone holder mechanism allows you to pull out the entire microphone holder with one hand and rotate it in 90° increments, even after the microphone has been screwed in place with the microphone or shock mount.

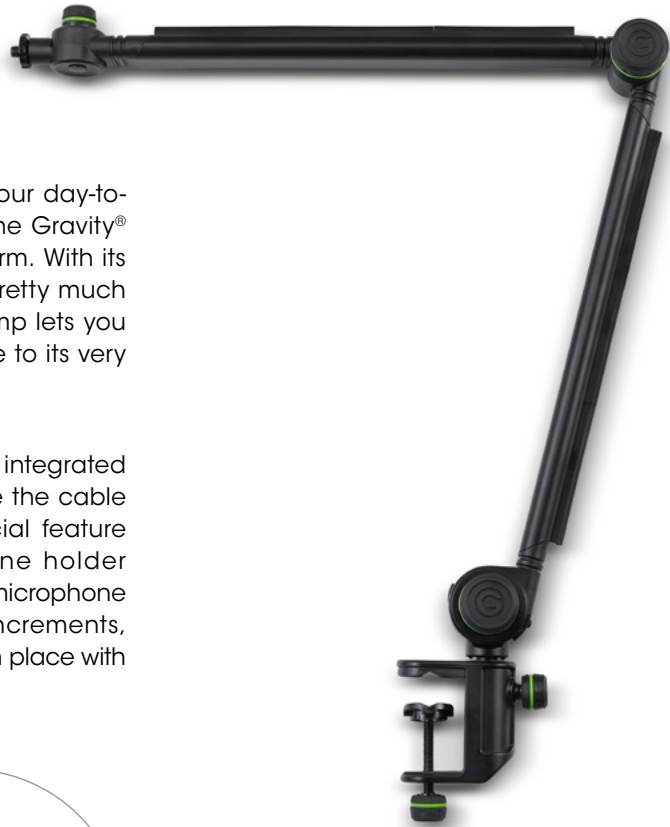

Product number	GMSTBA01
Product type	Stands and tripods
Type	Microphone stands
Arm material	Aluminum
Arm colour	Black
Max. height	810 mm
Base type	Table mount
Base material	Steel
Clamping width	15 - 54 mm
Max. load capacity	1.5 kg
Interchangeable rings	2 x 25 mm, 3 x 15 mm
Black ring pack included	Yes
Weight	0.96 kg



## MA TH 01 B

### TABLET HOLDER WITH VARI®-ARM

Tablets are extremely versatile tools and are not only useful for business and private applications, but also in the studio and on the live stage. Despite their practicality - with their countless apps designed for musicians, DJs, podcasters, and producers - it has always been a challenge to position a tablet effectively, just the way you want it and without hassle.

The Gravity® MA TH 01 B Tablet Holder with VARI®-ARM makes it possible. Its continuously variable clamps hold tablets of any size firmly in place, while the VARI®-ARM allows the tablet to be freely positioned. Once all joints are tightened using the single central setscrew, the entire VARI®-ARM is locked in place and your tablet remains in the position you originally set. Thanks to the solid mounting bracket with its wide clamping range (15-35 mm), the MA TH 01 B can also be mounted to a wide variety of stands, tabletops and other objects - and then quickly removed again.

Your tablet won't slip out of position anymore with the Gravity® MA TH 01 B Tablet Holder - whether you're sitting at your desk recording a podcast, singing in the studio, reading your music scores on stage, or just lying comfortably on the couch watching your favourite show.



Product number	GMATH01B
Product type	Microphone accessories
Type	Tablet holder
Material Vari-Arm	Steel
Material tablet holder	Plastic
Colour	Black
Mounting	Microphone stand, tabletop
Min. device size (screen size)	9.1"
Max. device size (screen size)	14.1"
Fits tube diameters	15 mm - 35 mm
Interchangeable rings	2x 15 mm, 1x 25 mm
Black ring pack included	Yes
Weight	0.66 kg

# MULTIMEDIA EQUIPMENT

## SA 6131 B

### TABLETOP MONITOR MOUNT SWIVEL ARM

The SA 6131 B is an elegant steel and die-cast aluminum construction monitor screen mount arm. It is adjustable in all directions and features an ingenious counterbalance design for easy screen height adjustment. The integrated cable management system ensures a clean and uncluttered installation. The producer screen arm ships with desk clamp and grommet for a wide variety of secure mounting options.



Product number	GSA6131B
Product type	Stands and tripods
Type	Other stands and tripods
Material	Aluminum, steel
Colour	Black
Mounting option	Barrier strip, table mount
Suitable for screen size	13" - 27"
Number of screens	1
Screen weight max.	9 kg
Also suitable for curved screens	Yes
Vesa standard	100 x 100 mm, 75 x 75 mm
TILT movement	-40° +40°
Swivel	180°
Rotate	360°
Max. length of arm	527 mm
Max. height of arm	620 mm
Height admission pole	310 mm
Height adjustment	Continuous
Cable management	Yes
Weight	3.22 kg



Gas spring and adjustable spring tension gauge



Swivel 180°, tilt -40° / +40°, rotation 360°, adjustable height



Integrated cable management



Table clamp included

## SA BTRAY 1

### BEAMER TRAY FOR 35 MM STANDS

This convenient tray mounts to any 35 mm diameter pole and converts standard speaker stands into a multimedia projector stand. Providing a flat surface of 42 x 38 cm, it also accommodates laptops, blue-ray players, monitor speakers and other equipment up to 30 kg weight. The strong all-steel construction features a 10 mm lip around the edges to add rigidity and prevent items from falling off.



Product number	GSABTRAY1
Product type	Stands and tripod accessories
Type	Universal monitor mount
Material	Steel
Surface	Powder coated
Colour	Black
Suitable for tube diameter	35 mm
Max. load	30 kg
Length base plate	380 mm
Width base plate	420 mm
Material thickness base plate	2 mm
Weight	2.94 kg

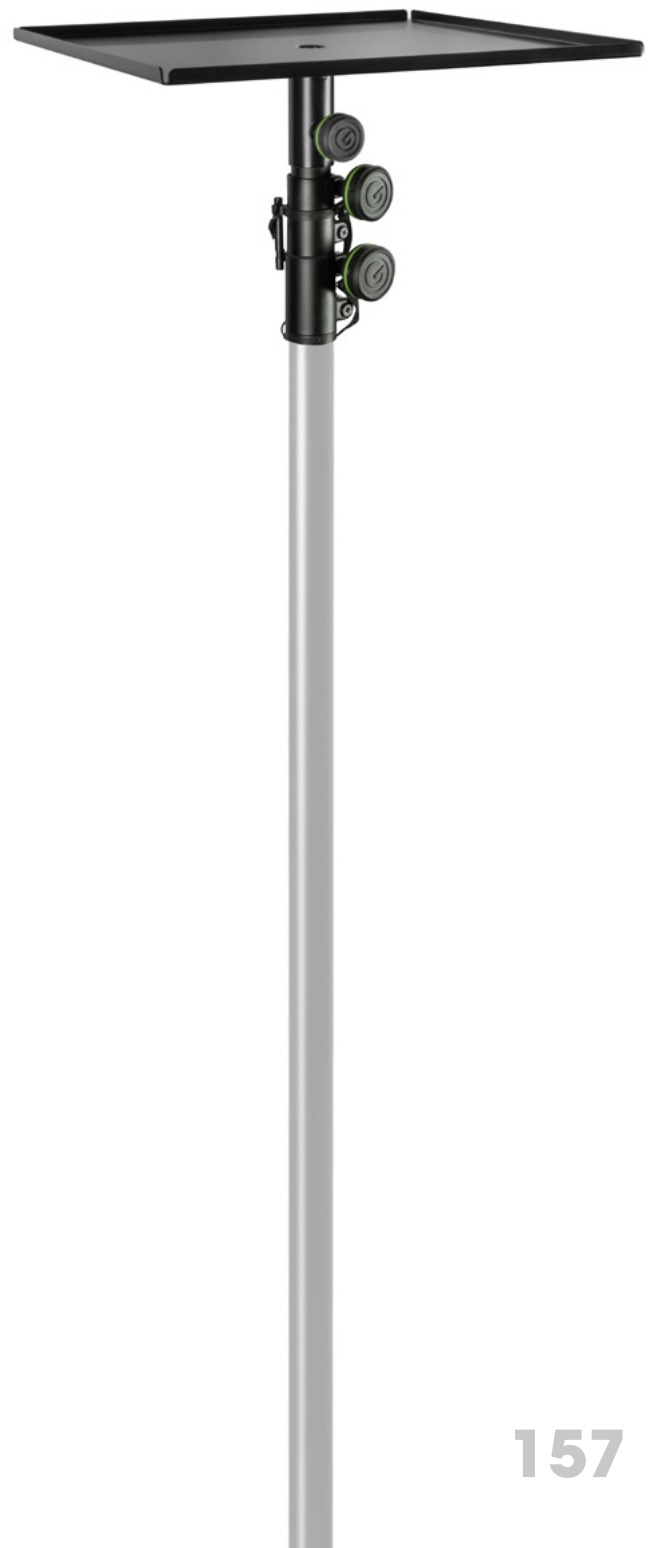

# MULTIMEDIA EQUIPMENT

## VA PH 1 B

### SMARTPHONE HOLDER

The strong mobile phone clip is padded with EVA and rubber to protect against scratches on the smartphone's display or housing. Once clamped, it can be rotated completely freely through 360° and tilted through 90° in four directions. The smartphone remains firm and secure in any position.

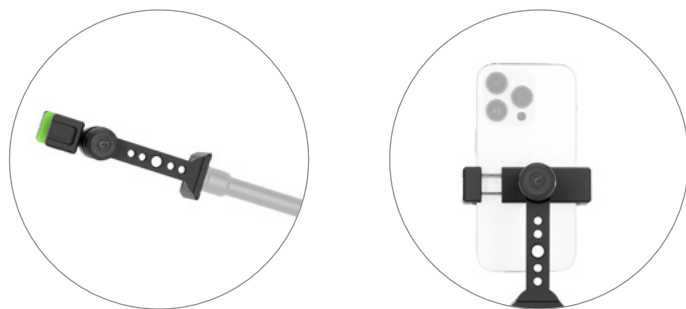

Product number	GVAPH1B
Product type	Stands and tripods
Type	Smartphone holder
Mounting	Arca swiss plate 45 x 38 mm
Material	Aluminium
Colour	Black
Threaded connections	2 x 3/8", 6 x 1/4"
Phone clamp connections	1 x cold shoe, 1 x 1/4" thread
Inner coating of the clamp	EVA padded, rubber
Rotatable	360°
Tilt angle	+/- 90° (left, right, up and down)
Maximum device size	94 mm
Minimum device size	58 mm
Max. device depth	15 mm
Other features	Portrait and landscape format
Weight	0.16 kg

## VS TRIPOD 01 B

### UNIVERSAL TRIPOD TABLE STAND

Fold it up, pack it away and always have it with you.

With the Gravity® mini tabletop tripod, you have an extremely compact companion that folds up to fit in any jacket pocket and offers countless possibilities for use: as a tabletop tripod for mobile recording of podcasts, as a flexible stick for field recordings and action cam recordings, and even as an attachment for full-grown tripods.

The VS TRIPOD 01 B tripod table stand has a ball head with a 1/4" thread at the top end to freely align recorders, cameras or action cams. The ball head can be folded down sideways up to 90°. The three tripod legs can be height-adjusted in four steps via the adjustment ring.

When out and about, the legs can be folded in and used as an ergonomic handle, for example, for one-handed camera movements with a mounted action cam. It becomes even more versatile when you use one of the 1/4" internal threads integrated in each foot to screw the SV TRIPOD 01 B onto a larger tripod or microphone boom. This way you are always perfectly equipped for video and audio recordings. Whether on the road or in the studio.



Product number	GVSTRIP0D01B
Product type	Stands and tripod accessories
Type	Camera stand
Material	Aluminum
Surface	Powder coated
Colour	Black
Threaded connector 1	1/4" male
Threaded connector 2	1/4" female
Height	85 - 215 mm
Transport length	240 mm
Max. load capacity	2 kg
Interchangeable rings	1 x 15 mm
Black ring pack included	Yes
Weight	0.24 kg



# MULTIMEDIA EQUIPMENT

## LED STICK 1 B

### COMPACT MAGNETIC AND DIMMABLE LED LIGHT BAR WITH USB CHARGING PORT

This compact light bar helps you to generate light wherever you need thanks to the integrated rechargeable battery.

You can choose from two different whites (cool and warm white), switch and continuously dim them as desired.

Another absolute highlight are the magnets. The led light bar is equipped with four strong magnets at the bottom, which allow you to attach the lamp to any metal object (e.g. racks, music stands, cases, etc.). This way you don't need to screw the lamp.

And there is more to it than that. Thanks to the two 3/8" threads, the LED STICK 1 B can be mounted both horizontally and vertically to any microphone stand.

For even more flexibility in positioning the light, you can rotate the light bar so that the illumination is always directed to where you need it. For safe transport, the light bar has a wrist strap that allows you to hold the LED STICK 1 B securely.



Product number	GLEDSTICK1B
Product type	Stands and tripod accessories
Type	Light bar
Material	Aluminum, plastic
Colour	Black
Length of light bar	330 mm
Number of LEDs	27
Colour of LEDs	Warm white / cold white
Number of threads	2
Thread type	3/8"
USB Port	Typ C, DC 5V, 5.2A
Switch levels	Cold white, warm white, dimmer, off, on
Colour temperature	Cold white (6000 - 6500K), warm white (3000 - 3500K)
Colour rendering index (CRI)	> 80
Power consumption	6 W
Battery runtime	With 100 % brightness approx. 4 hrs.
Battery charging time	With a 5V 2A charger approx. 3 Hrs.
Dimensions (L x H x W)	445 mm x 50 mm x 32 mm
Accessories (included)	2 meter USB cable, wrist strap
Weight	0,5 kg



## LED PLT 2B

### DIMMABLE LED DESK AND PIANO LAMP WITH USB CHARGING PORT

This ultra slim and elegant T-shape desk lamp with silicone coated gooseneck provides uniform illumination exactly where you need it. It features a strip of 18 LEDs that are switchable between warm or cool white (approx. 3,000/6,000 K), and the touch sensitive power button doubles as a stepless dimmer switch. The gooseneck section is easily flexible yet stays put where you bend it. The Gravity® T-shape desk lamp integrates a convenience USB type A port for charging smart phones and tablets and comes with a 12V power adapter. It also makes a great piano lamp, workbench light or bedside reading lamp.



Product number	GLEDPLT2B
Product type	Stands and tripod accessories
Number of LEDs	18
Colour of LEDs	White
Gooseneck length	160 mm
Total length	560 mm
USB Port	Type A, DC 5 V 1.5 A
Switches	Colour selector, touch sensitive button
Switch levels	Continuous, off, on, warm white / cold White
Colour temperature	3000K - 6000 K
Colour rendering index (CRI)	> 75
Current draw	8 W (max. 19 W with USB)
Power supply	AC 100-240 V, DC 12 V 1 A (included)
Weight	0.75 kg

# MULTIMEDIA EQUIPMENT

## HP HTT 01 B

### TABLE-TOP HEADPHONES STAND

Designed for both home and professional use, this elegant table-top headphones stand securely holds up to two large sets of headphones. Convenient slots on the holder facilitate convenient and tidy routing and storage of cables or ear buds. The stand features a die-cast aluminum base and tower construction, whereby the holder itself is made of plastic with a rubberised finish.



Product number	GHPHTT01B
Product type	Headphone holder
Material	Aluminum, plastic
Colour	Black
Support width	60 mm
Support depth	100 mm
Height	280 mm
Dimensions base (W x L)	128 x 105 mm
Weight	0.48 kg



## HP HMS 01 B / HP HTC 01 B / HP HWMB 01 B

HEADPHONES HOLDER FOR MICROPHONE STAND / TABLE MOUNT / WALL MOUNT

Product number	GHPHMS01B	GHPHTC01B	GHPHWM01B
Product type	Headphone holder	Headphone holder	Headphone holder
Material	Plastic, steel	Plastic, steel	Plastic, steel
Mounting	Microphone stand	Table	Wall
Colour	Black	Black	Black
Support width	60 mm	60 mm	60 mm
Support depth	100 mm	100 mm	100 mm
Suitable for tube diameter	up to 30 mm		
Clamping range		up to 45 mm	
Interchangeable rings	1 x 15 mm	1 x 15 mm	No
Black ring set included	Yes	Yes	No
Weight	0.18 kg	0.25 kg	0.2 kg







# SEATS & BENCHES

Gravity® offers a versatile selection of ergonomic seats and benches specifically designed for musicians. Whether it's in the studio, on stage, or at home, Gravity's seats and benches provide optimal comfort and support for any playing position. The height-adjustable models allow for individual customisation to fit any body size and seating preference, while durable materials and thoughtful design ensure longevity and stability.

# SEATS & BENCHES



## FEATURES



Ergonomically shaped seat with adjustable height and tilt angle



Backrest adjustable in height and depth



VARI®-Foot technology for leveling uneven floors



Folds down conveniently

## FM SEAT 1 BR

### HEIGHT ADJUSTABLE STOOL WITH FOOT AND BACKREST

The standing aid FM SEAT 1 BR by Gravity is suitable for universal use on stage, in the rehearsal room or at home while practising; for guitarists, bass players, pianists, string players, wind players and singers. It boasts several of Gravity's special hallmark features.

Let's take a look at the seat first: It has an attractive leatherette covering and can be tilted forwards or backwards at continuously variable angles.

Let's move onto the adjustment options offered by this standing aid: The frame is made of solid steel and with a generous height adjustment range of 67 cm to 97 cm, a comfortable seating position can be achieved for any body height. Even more comfort is provided by the FM BR 1 backrest. It is also covered in pleasant leatherette and can be flexibly adjusted in height and distance to the seat, allowing you to find your perfect sitting posture. The continuously height-adjustable footrest additionally relieves the back while also allowing one or both legs to be rested. Another extremely practical aspect is the integrated levelling foot. The tubular base construction is fitted with our KS Vari-Foot® 1. This ensures a stable and secure footing even on uneven surfaces by means of a simple screw mechanism.

The FM SEAT 1 BR is quick to assemble by means of a folding mechanism and can be folded flat for transport - so it fits into any narrow gap when loading.

Product number	GFMSEAT1BR
Product type	Benches and seats
Type	Stool
Stand material	Steel
Stand surface	Powder coated
Seat material	Imitation leather
Backrest material	Imitation leather
Height adjustment	Locking clamp screw
Height adjustment backrest	Locking clamp screw
Depth adjustment backrest	Locking clamp screw
Min height	670 mm
Max height	970 mm
Max. load capacity	100 kg
Weight	8.7 kg

# SEATS & BENCHES

## FG SEAT 1

### MUSICIAN SEAT WITH GUITAR STAND

Compactness is the key word here because who isn't familiar with forgetting their guitar stand in a hurry on the way to the gig, the stool at the concert venue not being comfortable and the guitar slipping off your leg because the stool is too high. For this there is now the Gravity® FG SEAT 1 musician seat. A clever stool with integrated stand and adjustable footrest for a bar-like feeling on every stage and at home.

The guitar bar stool is a round musician seat designed for guitarists, bassists and singer-songwriters. It boasts several of Gravity's special hallmark features. Firstly, there is the design and functionality of the seat: It is made from a combination of leatherette and fabric. This ensures that the seat surface is breathable at the right places, which significantly increases sitting comfort. This combination also gives the stool a unique and appealing design.

A second highlight is the sophisticated stable body mount for your guitar. This can be folded down and can securely hold any conventional guitar, whether acoustic or electric. Further up, the neck of the guitar is held by a pull-out arm, which can be locked to protect your instrument from any falls. At the touch of a button, the arm can be elegantly retracted under the seat when not in use. For transport, the FG SEAT 1 fits into any narrow space as it can be folded flat.

A third very practical aspect is the particularly stable and height-adjustable footrest. This can be easily pulled up with your foot and enables you to quickly find the optimal leg angle. This way, you always keep your guitar in a perfect position.

\*Not suitable for long-term use with guitars that have a nitro lacquer finish.



Product number	GFGSEAT1
Product type	Benches and seats
Type	Guitar barstool
Stand material	Die-cast aluminum, steel
Stand surface	Powder coated
Seat diameter	340 mm
Seat material	Fabric, imitation leather, foam material
Height	720 mm
Max. load capacity	120 kg
Seat colour	Black
For guitars with bodylength (maximum)	560 mm
Adjustable footrest	180 - 300 mm
Transport length	940 mm
Weight	6.28 kg



## FD SEAT 1

FOLDABLE ROUND MUSICIANS STOOL WITH  
ADJUSTABLE HEIGHT

The FD SEAT 1 from Gravity® is a round musician's chair for universal use: In the studio, on stage, in the rehearsal room or at home practicing. For drummers, guitarists, bassists, pianists, strings or wind instruments. It boasts special characteristics typical of Gravity®.

On the one hand, the functionality of the seat: In contrast to most current models from other manufacturers, it is not only made of leather/ imitation leather or fabric, but of a mix of materials. This ensures that the seat surface is breathable at the right places, significantly increasing comfort. In addition, this mix gives the FD SEAT 1 an unmistakable and appealing design that sets it apart from the crowd.

A second highlight is the ingenious height adjustment: It is based on a threaded rod, but with a certain twist. For fine adjustment, simply loosen the locking screw and turn the seat in the appropriate direction. For larger height adjustments, however, the seat surface can simply be pulled up or down and then tightened with the knurled nut.

And thirdly, the Gravity® chair has a particularly sturdy leg construction made entirely of metal. The legs are double-braced and the feet are large enough to ensure stability and reliability.



Product number	GFDSEAT1
Product type	Benches and seats
Type	Musicians chair, round
Stand material	Die-cast aluminum, steel, zinc die-cast
Stand surface	Powder coated
Seat diameter	330 mm
Seat material	Fabric, foam, imitation leather
Height adjustment	Threaded rod with lock nut
Setting circle diameter	520 mm
Min. height	560 mm
Max. height	800 mm
Max. load capacity	100 kg
Seat colour	Black
Weight	4.8 kg

# SEATS & BENCHES



## FEATURES



Breathable and comfortable seat



Convenient height-adjustment mechanism and handles



VARI®-Foot technology for leveling uneven floors



Solid steel construction



## FK SEAT 1

### HEIGHT-ADJUSTABLE FOLDING KEYBOARD BENCH

Gravity's FK SEAT 1 keyboard bench, which can be used for a variety of different applications on the stage, in the rehearsal studio or while practicing and composing at home, is for keyboard players, guitarists, bass players, and musicians of string and wind instruments.

It boasts several of Gravity's special hallmark features.

On the one hand, the seat has a range of functions: it is covered with a mix of leatherette and fabric to ensure the seat surface can breathe in all the right places. This provides an elevated level of comfort. The FK SEAT 1's unmistakable and appealing design is also made possible by this combo of materials.

On the other hand, it is worth noting that the bench's height can be adjusted to provide the optimal sitting position for every body size and every type of instrument. The necessary stability is provided by the solid steel frame.

The integrated leveler is another very useful element, and the tubular base construction is outfitted with our KS VARI®-Foot 1. The simple screw-lock mechanism lets the bench stay firmly and securely fixed in place, even on bumpy surfaces.

The FK SEAT 1's 1 hinge mechanism allows the bench to be quickly set up, taken down and folded flat for transport. It can thus fit into virtually any space during loading.

Product number	GFKSEAT1
Product type	Benches and seats
Type	Keyboard bench
Stand material	Steel
Stand surface	Powder coated
Seat Dimensions (W x D)	610 x 330 mm
Seat material	Fabric, foam, imitation leather
Height adjustment	5 levels of height adjustment
Min. height	470 mm
Max. height	610 mm
Max. load capacity	120 kg
Seat colour	Black
Weight	8.6 Kg



# BAGS & TRANSPORT SYSTEMS

Gravity® bags offer you an easy and safe transport of your stands. The thick padding and the water repellent material make sure your equipment is absolutely safe.

# TRANSPORT SYSTEMS

## CART M 01 B

### MULTIFUNCTIONAL TROLLEY (MEDIUM)

Sound technicians, DJs and stagehands: Take the weight off your load with a multi-functional cart. The Gravity® Cart chassis is made of steel to ensure rigidity. Two fixed and two rotating low-rolling resistance, anti-slip rubber tyres provide extra manoeuvrability. The Gravity® Cart is your trusty companion before and after every show. And the best thing is: The light-weight, compact-folded, multi-functional cart lifts easily from the tour bus while also performing effortlessly when fully loaded with equipment. With its (up to 0.98 m) extendable chassis and 150 kg load capacity, your equipment is quickly and safely transported to and from the stage. And thanks to its optimal ergonomic design: without straining your back.



Product number	GCARTM01B
Product type	Multifunctional trolley
Handle material	Steel
Handle colour	Black
Drawer material	Steel
Dimensions unfolded (L x W x H)	650 - 1090 x 400 x 800 mm
Dimensions folded (L x W x H)	750 - 1130 x 400 x 195 mm
Dimensions loading platform (L x W x H)	560 - 980 x 265 x 175 mm
Length	650 - 1130 mm
Front wheels Ø	80 mm
Rear wheels Ø	150 mm
Material front wheels	Rubber
Material rear wheels	PU
Track width rear / front	340 / 305 mm
Max. load capacity	150 kg
Weight	11 kg

## CART L 01 B

### MULTIFUNCTIONAL TROLLEY (LARGE)

Easy work with heavy equipment.

Sound technicians, DJs and stagehands: Take the weight off your load with a multi-functional cart. The Gravity® Cart L 01 B chassis is made of steel to ensure stability. Two fixed and two rotating low-rolling resistance, anti-slip tyres provide extra maneuverability even for higher curbs or rough terrain.

The Gravity® Cart is your trusty companion before and after every show. And the best thing: The light-weight, compact-folded, multi-functional cart lifts easily from the tour bus while also performing effortlessly when fully loaded with equipment. With its up to 1.35 m extendable chassis and 170 kg load capacity, your equipment is quickly and safely transported to and from the stage. And thanks to its optimal ergonomic design: without straining your back.



Product number	GCARTL01B
Product type	Multifunctional trolley
Handle material	Steel
Handle colour	Black
Drawer material	Steel
Dimensions unfolded (L x W x H)	810 - 1345 x 500 x 950 mm
Dimensions folded (L x W x H)	855 - 1390 x 500 x 300 mm
Dimensions loading platform	715 - 1259 x 340 x 285 mm
Length	810 - 1390 mm
Front wheels Ø	200 mm
Rear wheels Ø	250 mm
Material front wheels	PU
Material rear wheels	PU
Track width rear / front	430 / 380 mm
Max. load capacity	170 kg
Weight	16.5 kg

# TRANSPORT SYSTEMS

## BG CART M 1

### WAGON BAG FOR CART M 01 B

The BG CART M1 wagon bag is a practical solution for carrying smaller items of equipment with the Gravity® CART M 01 B.

Made from robust, water-repellent 1680D nylon, it provides protection and stability for your equipment. The simple assembly allows for easy attachment to the handles of the Gravity® CART Medium. The adjustable straps allow the length of the bag to be adapted to the set length of the CART, so that the bag remains flexible and foldable even after assembly.

The Gravity® BG CART M1 wagon bag is robust, flexible and simply practical - an indispensable aid for transporting equipment.



Product number	GBGCARTM1
Product type	Wagon bag
Material	1680D nylon
Colour	Black
Depth	220 mm
Width	580 - 1000 mm
Height	650 mm
Total width	530 - 1005 mm
Weight	1.18 kg



## CART L 01 AC 1 SET 1

### RAPID DESK FOR CART L 01 B INCL. BARS

Turn your Gravity CART into a mobile workspace!

With the CART L 01 AC1 SET 1 you can turn your existing CART L 01 B into a stable, mobile work surface in no time at all. Both the bars and the table are made of powder-coated steel and - like all Gravity stands - are extremely stable and sturdy. In combination, a generous maximum load capacity of up to 50 kg is achieved on the top tier. On the lower tier, up to 120 kg can be transported.

For assembly, the screwed supports are simply inserted into the recesses in the middle of the Rapid Desk, the trolley is unfolded and extended to the now maximum possible dimension. No further fastening or screwing of the support is necessary.



## CART L 01 AC 1

### RAPID DESK EXTENSION FOR CART L 01 B

Item No.: GCARTL01AC1

<b>Product number</b>	<b>GCARTL01AC1SET1</b>
Product type	Multifunctional trolley
Max. load capacity	50 kg
Weight	7.32 kg
<b>Product number</b>	<b>GCARTL01AC1</b>
Product type	Rapid desk extension
Material	Steel
Surface	Powder coated
Colour	Black
Length	415 mm
Height with screw	80 mm
Height without screw	35 mm
Weight (pair)	0.68 kg
Max load top tier / lower tier	50 kg / 120 kg
<b>Product number</b>	<b>GKSRD1</b>
Product type	Stands and tripods
Material	Steel
Surface	Powder coated
Colour	Black
Max. support depth	480 mm
Max height	43 mm
Dimensions (W x D)	1000 x 465 mm
Weight	6.62 kg



CART IS NOT INCLUDED

# CARRY BAGS



## FEATURES



Robust sandbag made of waterrepellent 1680D Nylon



Inner bags with velcro fastener can be filled comfortably



Can be filled with sand, gravel or similar to weight down



Practical lugs

## BG SB S1 / L1

### FILLABLE SANDBAG WITH LUGS FOR TRIPODS SMALL / LARGE

The BG SB sandbags are available in two versions: SMALL for mic stands and LARGE for C-stands and speaker and lighting stands. Handling the bags is as easy as it is effective. Each bag has two inner bags that can be filled with sand, gravel or other materials as desired - and fit perfectly into the two recesses. The BG SB sandbag is then simply set down on the stand base or leg to hold the stand down firmly and reliably. The carrying handles offer additional comfort so that the bags can be gripped and repositioned with one hand.

To ensure that potentially heavily filled bags do not slide down on steep stand legs, they have a special non-slip mesh surface on the underside. In this way, the BG SB can be quickly and easily attached, removed and set back down again during hectic changeovers. (Velcro fasteners and straps are not necessary to fasten the bag to the stand leg). If strong winds are an issue, you can use the integrated metal eyelets on the corners to securely connect the bags to the stand using cable ties or rope.

For worry-free use on open-air stages and restaurant terraces, or for outdoor film shoots, the BG SB features a water-repellent outer material made of 1680D nylon, which makes sure that the sand or gravel inside do not become moist.

Product number	GBGSBS1	GBGSBL1
Product type	Stands and tripods	Stands and tripods
Type	Sandbag	Sandbag
Number of inner bags	2	2
Colour	Black	Black
Material	1680D nylon, 420D nylon, anti-slip mesh cloth	1680D nylon, 420D nylon, anti-slip mesh cloth
Latch	Velcro, zip	Velcro, zip
Width	340 mm	420 mm
Height	210 mm	260 mm
Depth	45 mm	45 mm
Weight	0.48 kg	0.71 kg



# CARRY BAGS



## BG SS 2 TB

TRANSPORT BAG FOR TWO TRAVELER SPEAKER STANDS

Product number	GBGSS2TB
Product type	Stands and tripod accessories
Type	Transport bag
For number of stands	2
For type of stand	Traveler speaker stand
Colour	Black
Material	Nylon 600D
Thickness of the padding	15 mm
Latch	Double zip
Width	700 mm
Height	110 mm
Depth	200 mm
Weight	1 kg



## BG SS 1 XXL B

TRANSPORT BAG FOR 1 LARGE SPEAKER STAND 1700 MM

Product number	GBGSS1XXLB
Product type	Stands and tripod accessories
Type	Transport bag
For number of stands	1
For type of stand	Speaker tripod
Colour	Black
Material	1680D nylon
Thickness of the padding	10 mm
Latch	YKK double zip
Width	1740 mm
Height	170 mm
Depth	150 mm
Weight	1.5 kg





## BG SS 2 LB

TRANSPORT BAG FOR 2 SPEAKER STANDS 1200 MM

Product number	GBGSS2LB
Product type	Stands and tripod accessories
Type	Transport bag
For number of stands	2
For type of stand	Speaker tripod
Colour	Black
Material	Nylon 600D
Thickness of the padding	15 mm
Latch	Double zip
Width	1200 mm
Height	190 mm
Depth	290 mm
Weight	1.6 kg



## BG SS 2 XLB

TRANSPORT BAG FOR 2 SPEAKER STANDS 1450 MM

Product number	GBGSS2XLB
Product type	Stands and tripod accessories
Type	Transport bag
For number of stands	2
For type of stand	Speaker tripod
Colour	Black
Material	Nylon 600D
Thickness of the padding	10 mm
Latch	Double zip
Width	1450 mm
Height	180 mm
Depth	280 mm
Weight	1.86 kg



# CARRY BAGS



## BG SS 1 XLB

TRANSPORT BAG FOR 1 SPEAKER STAND 1490 MM

Product number	GBGSS1XLB
Product type	Stands and tripod accessories
Type	Transport bag
For number of stands	1
For type of stand	Speaker tripod
Colour	Black
Material	Nylon 1680D
Thickness of the padding	10 mm
Latch	YKK double zip
Width	1490 mm
Height	170 mm
Depth	150 mm
Weight	1.1 kg



## BG DBLS 331

TRANSPORT BAG FOR 2 DISTANCE POLES

Product number	GBGDBLS331
Product type	Stands and tripod accessories
Type	Transport bag
For number of stands	2
For type of stand	Distance bar
Colour	Black
Material	Nylon 1680D
Thickness of the padding	10 mm
Latch	YKK double zip
Width	1420 mm
Height	120 mm
Depth	140 mm
Weight	0.9 kg







## BG MS 1 B

TRANSPORT BAG FOR 1 SPEAKER STAND 1150 MM

Product number	GBGMS1B
Product type	Stands and tripod accessories
Type	Transport bag
For number of stands	1
For type of stand	Microphone stand
Colour	Black
Material	Neoprene
Thickness of the padding	1 mm
Latch	Zipper
Width	1150 mm
Height	120 mm
Depth	25 mm
Weight	0.3 kg



## BG SS 2 B

TRANSPORT BAG FOR 2 SPEAKER STANDS 1070 MM

Product number	GBGSS2B
Product type	Stands and tripod accessories
Type	Transport bag
For number of stands	2
For type of stand	Speaker tripod
Colour	Black
Material	Nylon 600D
Thickness of the padding	15 mm
Latch	Double zip
Width	1070 mm
Height	190 mm
Depth	290 mm
Weight	1.45 kg



# CARRY BAGS



## BG MS 6 B

TRANSPORT BAG FOR 6 MICROPHONE STANDS

Product number	GBGMS6B
Product type	Stands and tripod accessories
Type	Transport bag
For number of stands	6
For type of stand	Microphone stand
Colour	Black
Material	Nylon 1680D
Thickness of the padding	5 mm
Latch	YKK zipper
Width	1100 mm
Height	330 mm
Depth	330 mm
Weight	1.8 kg



## BG MS 6 SB

TRANSPORT BAG FOR 6 SHORT MICROPHONE STANDS

Product number	GBGMS6SB
Product type	Stands and tripod accessories
Type	Transport bag
For number of stands	6
For type of stand	Microphone stand
Colour	Black
Material	Nylon 1680D
Thickness of the padding	5 mm
Latch	YKK zipper
Width	680 mm
Height	330 mm
Depth	330 mm
Weight	1.37 kg



## BG MS PB 4 B

TRANSPORT BAG FOR 4 MICROPHONE STANDS WITH PLATE BASE

Product number	GBGMSPB4B
Product type	Stands and tripod accessories
Type	Transport bag
For number of stands	4
For type of stand	Microphone stand
Colour	Black
Material	Nylon 1680D
Thickness of the padding	5 mm
Latch	YKK double zip, zip
Width	1220 mm
Height	320 mm
Depth	170 mm
Weight	2.1 kg



## BG WBL5 431 CB

TRANSPORT BAG FOR SMALL SQUARE BASE PLATE

Product number	GBGWBL5431CB
Product type	Stands and tripod accessories
Type	Transport bag
Colour	Black
Material	Nylon 1680D
Thickness of the padding	5 mm
Latch	YKK zipper
Width	390 mm
Height	390 mm
Weight	0.37 kg



# CARRY BAGS



## BG PD 1

TRANSPORT BAG FOR SQUARE BASE PLATE 600 X 600 MM

Product number	GBGPD1
Product type	Stands and tripod accessories
Type	Transport bag
Colour	Black
Material	Nylon 1680D
Thickness of the padding	5 mm
Latch	YKK zipper
Width	620 mm
Height	620 mm
Weight	0.95 kg



## BG WBL331

TRANSPORT BAG FOR SQUARE BASE PLATE

Product number	GBGWBL331
Product type	Stands and tripod accessories
Type	Transport bag
Colour	Black
Material	Nylon 1680D
Thickness of the padding	5 mm
Latch	YKK zipper
Width	600 mm
Height	600 mm
Weight	0.59 kg



## BG WB 2

TRANSPORT BAG FOR 270 MM ROUND BASE PLATE

Product number	GBGWB2
Product type	Stands and tripod accessories
Type	Transport bag
Colour	Black
Material	Nylon 1680D
Thickness of the padding	5 mm
Diameter	320 mm
Latch	YKK zipper
Weight	0.22 kg



## BG WB 123

TRANSPORT BAG FOR 450 MM ROUND BASE PLATE

Product number	GBGWB123
Product type	Stands and tripod accessories
Type	Transport bag
Colour	Black
Material	Nylon 1680D
Thickness of the padding	5 mm
Diameter	480 mm
Latch	YKK zipper
Weight	0.37 kg



# CARRY BAGS



## BG X2 RD B

TRANSPORT BAG FOR RAPID DESK AND DOUBLE X KEYBOARD STAND

Product number	GBGX2RDB
Product type	Stands and tripod accessories
Type	Transport bag
Colour	Black
Material	Nylon 1680D
Thickness of the padding	10 mm
Latch	Zipper
Number of compartments	2
Length of shoulder strap	1150 mm
Width	1050 mm
Height	96 mm
Depth	550 mm
Weight	1.75 kg



## BG KS 1 B

TRANSPORTBAG FOR KEYBOARD X STAND

Product number	GBGKS1B
Product type	Stands and tripod accessories
Type	Transport bag
For number of stands	1
For type of stand	Keyboard stand
Colour	Black
Material	Neoprene
Thickness of the padding	1 mm
Latch	Zipper
Width	560 mm
Height	1070 mm
Depth	25 mm
Weight	0.55 kg







## BG NS 1 B

### TRANSPORT BAG FOR MUSIC STAND

Product number	GBGNS1B
Product type	Stands and tripod accessories
Type	Transport bag
For number of stands	1
Colour	Black
Material	Nylon 1680D
Thickness of padding	10 mm
Latch	Zipper
Width	820 mm
Height	400 mm
Depth	100 mm
Weight	1.01 kg

## NOTES



[www.facebook.com/gravitystands](https://www.facebook.com/gravitystands)  
[www.youtube.com/gravitystands](https://www.youtube.com/gravitystands)  
[www.instagram.com/gravity\\_stands](https://www.instagram.com/gravity_stands)





## PREMIUM STANDS CATALOG

DESIGNED & ENGINEERED  
IN GERMANY.



[gravitystands.com](http://gravitystands.com)



[www.facebook.com/gravitystands](https://www.facebook.com/gravitystands)  
[www.youtube.com/gravitystands](https://www.youtube.com/gravitystands)  
[www.instagram.com/gravity\\_stands](https://www.instagram.com/gravity_stands)

The information contained in this publication, including numerical data, has been prepared as a general guide to the products, but intending buyers and users must satisfy themselves as to the suitability and the safety of the products for their particular purposes and duties. No responsibility is assumed for any errors herein. The company reserves the right to alter the designs and material specifications of products shown in this publication without notice.

Gravity is a registered brand of  **adam hall** experience event technology

**SOUND**  
TECHNOLOGY

**LIGHT**  
TECHNOLOGY

**STAGE**  
EQUIPMENT

**HARDWARE**  
FOR FLIGHTCASES

share the experience at [adamhall.com](http://adamhall.com)